

# THE 1/16 DIN TIMER



MODEL C48T INSTRUCTION MANUAL

## INTRODUCTION

*The C48 Timers (C48T) are a multi-purpose series of industrial control products that are field-programmable for solving various applications. This series of products is built around the concept that the end user has the capability to program different functions into the unit in order to adapt to different indication and control requirements.*

*The C48T unit, which you have purchased, has the same high quality workmanship and advanced technological capabilities that have made Red Lion Controls the leader in today's industrial market.*

*Red Lion Controls has a complete line of industrial indication and control equipment, and we look forward to servicing you now and in the future.*



UL Recognized Component,  
File #E137808



**CAUTION:**

Read complete instructions prior to installation and operation of the unit.



**CAUTION:**

Risk of electric shock.

## TABLE OF CONTENTS

<b>GENERAL DESCRIPTION</b> .....	1
Safety Summary .....	1
Block Diagram .....	2
<b>INSTALLATION &amp; CONNECTIONS</b> .....	3
Multiple Unit Stacking .....	3
Mounting Instructions .....	4
Unit Removal Procedure .....	4
Removing Unit Assembly .....	4
Installing Unit Assembly .....	4
Output Board .....	5
Replacing Relay Output Board .....	5
EMC Installation Guidelines .....	6
Wiring Connections .....	6
AC Versions (C48TXX0X).....	7
DC Versions (C48TXX1X) .....	7
Serial Communications Wiring.....	7
Run/Stop Input.....	7
User Input Plug Jumper .....	8
Output Wiring .....	8
Program Disable Plug Jumper .....	8
<b>FRONT PANEL DESCRIPTION</b> .....	9
Keypad Functions.....	9
<b>BASIC OPERATION</b> .....	10
Normal Operating Mode.....	10
Modifying A Secondary Display Parameter From the Front Panel .....	10
Protected Value Menu .....	10
Front Panel Accessible Functions With Program Disable .....	11
<b>PROGRAMMING GENERAL DESCRIPTION</b> .....	12
Programming Option Values .....	12
Programming Numeric Data Values.....	12
Digit Entry .....	12
Auto Scrolling.....	12

## TABLE OF CONTENTS (Cont'd)

<b>USER INTERFACE/PROGRAMMING MODES</b> .....	13
Programming Menu .....	13
Numeric Value Entry Method .....	13
Timer Range .....	13
Timer Operating Mode .....	13
Timer Reset at Power-up .....	17
Access Preset Values .....	17
Preset 1 Value .....	17
Preset 2 Value (Dual Preset Model only) .....	17
Preset 1 Track Preset 2 (Dual Preset Model only) .....	17
Access Output Time Values .....	18
Output Resolution .....	18
Output 1 Time Value .....	18
Output 2 Time Value (Dual Preset Model only) .....	18
Reverse Annunciator Logic .....	19
Output Power-Up State .....	19
User Inputs .....	19
User Input 1 .....	20
User Input 2 .....	20
User Input 3 .....	20
User F1 Key .....	20
Programming/Protected Parameter Menu Code (0-199) .....	20
Scroll Display .....	20
Serial Baud Rate and Parity Settings .....	21
Serial Unit Address (00-99) .....	21
Serial Abbreviate Mnemonics .....	21
Print Options .....	21
Print and Reset Timer Value .....	22
Factory Settings .....	22
Factory Settings Chart .....	22
User Settings Chart .....	23

## TABLE OF CONTENTS (Cont'd)

<b>RS-485 SERIAL COMMUNICATIONS</b> .....	24
Communication Format .....	24
Sending Commands And Data .....	24
Receiving Data .....	26
Serial Connections .....	27
Terminal Descriptions .....	27
Troubleshooting Serial Communications .....	27
Connecting To A Host Terminal .....	28
<b>APPENDIX "A" - APPLICATION EXAMPLE</b> .....	29
<b>APPENDIX "B" - SPECIFICATIONS AND DIMENSIONS</b> .....	30
<b>APPENDIX "C" - TROUBLESHOOTING</b> .....	32
<b>APPENDIX "D" - TERMINAL CONFIGURATIONS FOR C48 TIMERS</b> .....	34
<b>APPENDIX "E" - ORDERING INFORMATION</b> .....	35



## GENERAL DESCRIPTION

The Model C48 Timer is available in Single or Dual Preset models. The C48T features a 7 segment, 2 line by 6 digit reflective or backlit LCD display. For the backlit versions, the main display line is red and shows the timer value. The smaller secondary display line is green and can be used to view the preset values or output time values.

The C48 Timer can be configured for a variety of different operating modes to meet most timing application requirements. Twelve timing ranges are available from thousandths of a second to hours and minutes. Decimal Points are used to separate the time units (hours, minutes, seconds). Timing can be cumulative or can reset and start upon each power cycle. “On Delay” or “Off Delay”, “Single Shot”, and “Repetitive auto cycling” modes are all supported.

Four front panel push-buttons are used for programming the operating modes and data values, changing the viewed display, and performing user programmable functions, e.g. reset, etc. The C48T can be configured for one of two numeric data entry methods, digit entry or automatic scrolling. The digit entry method allows for the selection and incrementing of digits individually. The automatic scrolling method allows for the progressive change of one through all digit positions by pressing and holding the “up” or “down” button.

The C48 Timer has a Run/Stop Input, 3 programmable User Inputs, and a programmable front panel function key. The Run/Stop and User Inputs can be configured as sinking (active low) or sourcing (active high) inputs via a single plug jumper. The following functions are available for user inputs and the front panel function key:

Reset	Print Request
Store and Reset	Change Display
Program Disable	Reset Outputs
Store	

The dual preset models are available with solid-state or relay outputs. The single preset model has a solid-state and relay output in parallel. All solid-state outputs are available in a choice of NPN current sinking or PNP current sourcing, open-collector transistor outputs.

The Timer can also be configured to Continue or Stop timing upon reaching preset. The display can be programmed to stop at the preset value (Reset to Zero mode) or zero (Reset to Preset mode), or automatically reset to zero or preset and hold. Once stopped, the timer can be restarted by manually resetting it, or it can be programmed to restart when power is reapplied.

Optional RS485 serial communication capabilities allow for interrogation and modification of the preset and timer values.

The unit is constructed of a lightweight, high impact plastic case with a textured front panel and a clear display window. When properly installed, the front panel meets NEMA 4X/IP65 specifications for indoor use. Multiple units can be stacked horizontally or vertically. Modern surface-mount technology, extensive testing, plus high immunity to noise interference makes the C48 Timers extremely reliable in industrial environments.

## Safety Summary

All safety related regulations, local codes and instructions that appear in the manual or on equipment must be observed to ensure personal safety and to prevent damage to either the instrument or equipment connected to it. If equipment is used in a manner not specified by the manufacturer, the protection provided by the equipment may be impaired.

Do not use this unit to directly command motors, valves, or other actuators not equipped with safeguards. To do so, can be potentially harmful to persons or equipment in the event of a fault to the unit.

# BLOCK DIAGRAM

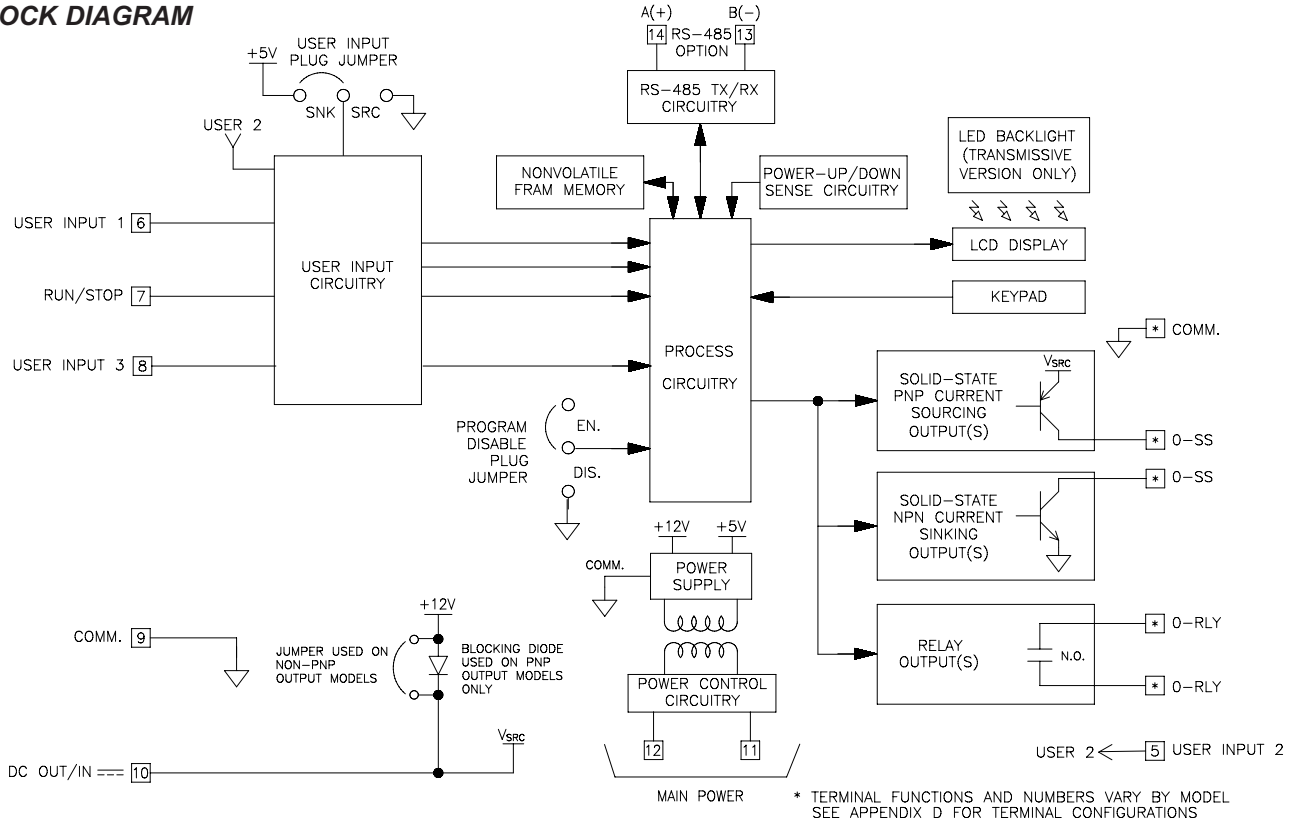

Figure 1, Block Diagram



# INSTALLATION & CONNECTIONS

The C48 Timer meets NEMA 4X/IP65 requirements for indoor use to provide a watertight seal in steel panels with a minimum thickness of 0.09 inch, or aluminum panels with a minimum thickness of 0.12 inch. The units are intended to be installed into an enclosed panel. The complete unit assembly (i.e. PC boards and bezel), **MUST** be in the case when mounting the unit.

## Multiple Unit Stacking

The C48T is designed for close spacing of multiple units. Units can be stacked either horizontally or vertically. For vertical stacking, install the panel latch with the screws to the sides of the unit. For horizontal stacking, the panel latch screws should be at the top and bottom of the unit. The minimum spacing from center line to center line of units is 1.96" (49.8 mm). This spacing is the same for vertical or horizontal stacking.

*Note: When stacking units, provide adequate panel ventilation to ensure that the maximum operating temperature range is not exceeded.*

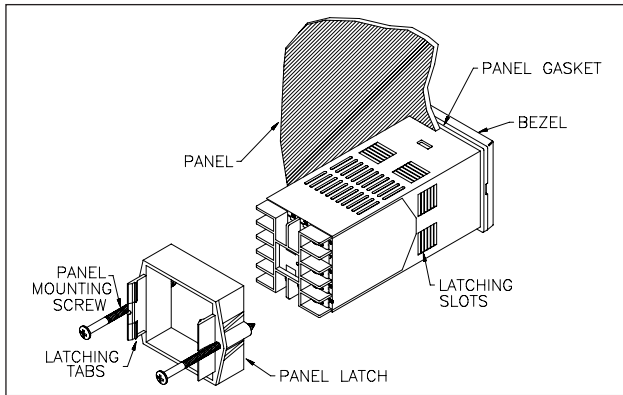

Figure 2, Panel Installation

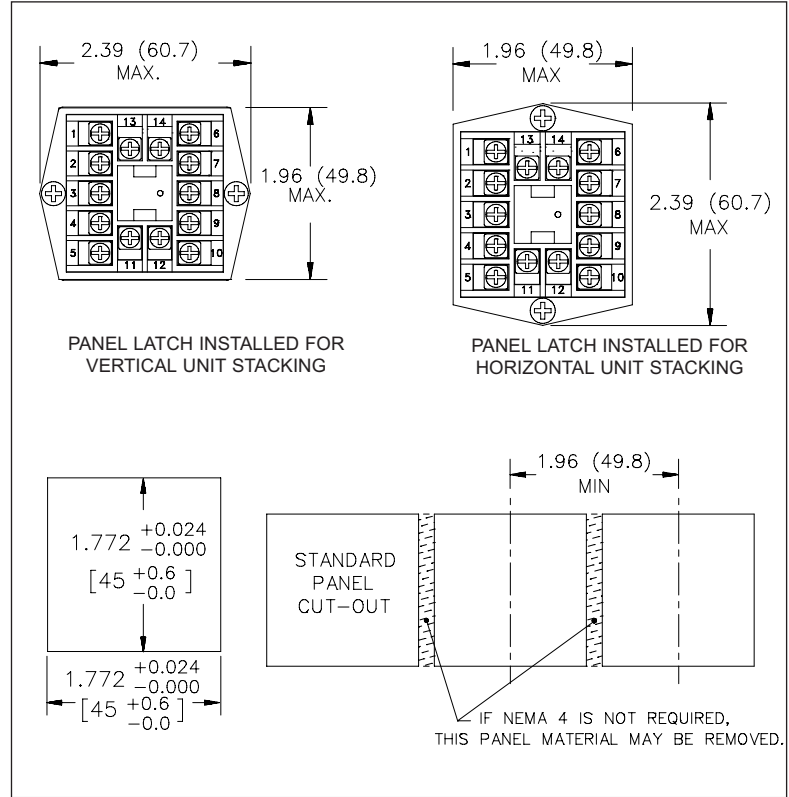

Figure 3, Multiple Unit Stacking

## Mounting Instructions

1. Prepare the panel cutout to the dimensions shown in Figure 3, Multiple Unit Stacking.
2. Remove the panel latch from the unit. Discard the cardboard sleeve.
3. Carefully remove the center section of the panel gasket and discard. Slide the panel gasket over the unit from the rear, seating it against the lip at the front of the case.
4. Insert the unit into the panel cutout. While holding the unit in place, push the panel latch over the rear of the unit, engaging the tabs of the panel latch in the farthest forward slot possible.
5. To achieve a proper seal, tighten the panel latch screws evenly until the unit is snug in the panel, torquing the screws to approximately 7 in-lbs. Overtightening can result in distortion of the panel, and reduce the effectiveness of the seal.

*Note: The installation location of the timer is important. Be sure to keep it away from heat sources (ovens, furnaces, etc.), and away from direct contact with caustic vapors, oils, steam, or any other process by-products in which exposure may affect proper operation.*



*Caution: Disconnect power to the unit and to the output control circuits to eliminate the potential shock hazard when removing the entire unit or unit assembly.*

## Unit Removal Procedure

To remove the entire unit (with case) from the panel, first loosen the panel latch screws. Insert flat blade screwdrivers between the panel latch and the case on either side of the unit, so that the latches disengage from the grooves in the case. Push the unit through the panel from the rear.

## Removing Unit Assembly

The unit assembly, shown in Figure 4, must be removed from the case to change plug jumper settings or to replace the relay output board. To remove the unit assembly, insert a flat blade screwdriver into the pry slot on either side of the unit. Twist the screwdriver handle until the unit is ejected enough to allow removal.

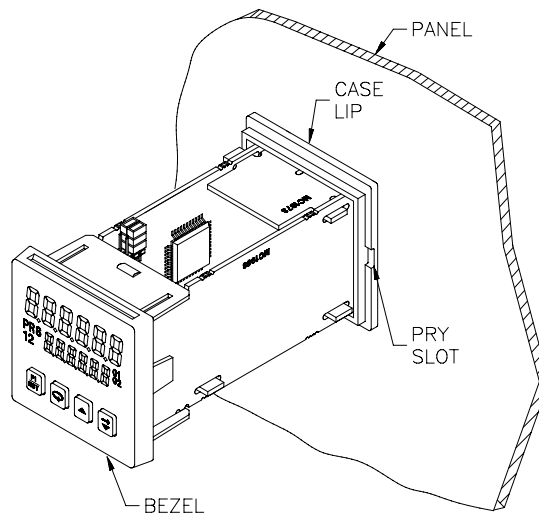

Figure 4, Unit Assembly

*Caution: The unit assembly contains electronic circuits that can be damaged by static electricity. Before removing the assembly, discharge static charge on your body by touching an earth ground point. It is also important that the unit assembly be handled only by the bezel. Additionally, if it is necessary to handle a circuit board, be certain that hands are free from dirt, oil, etc., to avoid circuit contamination that may lead to malfunction. If it becomes necessary to ship the unit for repairs, place the unit in its case before shipping it.*

## Installing Unit Assembly

To install the unit assembly, insert the assembly into the case until the bezel is fully seated against the lip of the case. Properly installing the unit assembly is necessary for watertight sealing.

## Output Board

The C48T is supplied with an output board installed. The output board is preconfigured for the type of output needed, based upon the Model ordered. See Ordering Information, page 35, for available models. All relay output boards are field replaceable.

### Replacing Relay Output Board

1. Remove the unit assembly. (See Removing Unit Assembly, page 4).
2. Lift up on the top bezel board latch while gently pulling out on the bezel/display board assembly. Do NOT remove the display board from the bezel.
3. Remove the output board by pulling it away from the other boards. Replace the output board by aligning the board to board connectors. Be certain connectors are fully mated.
4. Connect the bezel/display board assembly by guiding the board ends into the bezel latches. Slide the assembly on evenly until the display board connector is completely engaged and bezel latches are fully seated onto the boards.

*Note: When replacing the relay output board, be certain to install a new output board of the same type.*

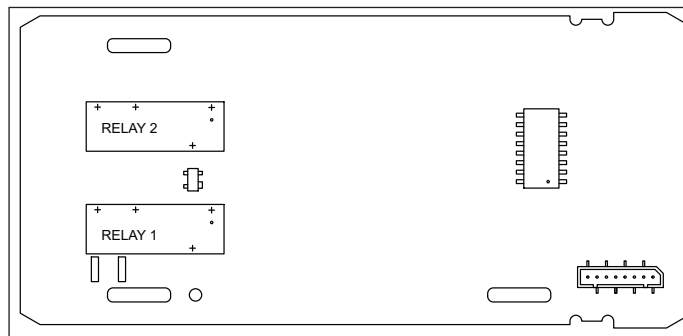
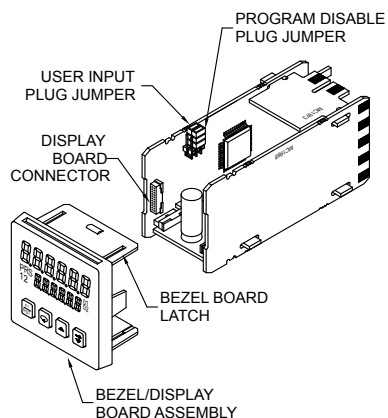
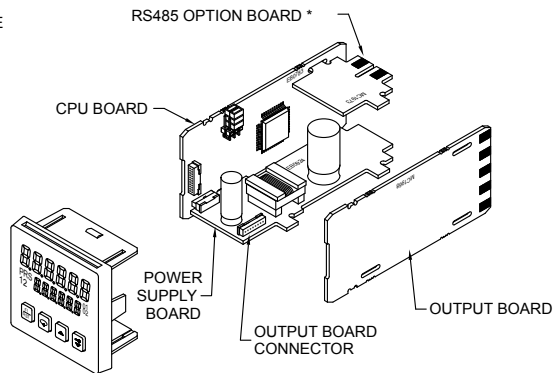

Figure 5, Relay Output Board



\* SOME MODELS DO NOT HAVE THE RS485 BOARD

Figure 6, Relay Output Board Replacement

## EMC INSTALLATION GUIDELINES

Although Red Lion Controls products are designed with a high degree of immunity to Electromagnetic Interference (EMI), proper installation and wiring methods must be followed to ensure compatibility in each application. The type of the electrical noise, source or coupling method into a unit may be different for various installations. Cable length, routing, and shield termination are very important and can mean the difference between a successful or troublesome installation. Listed are some EMI guidelines for a successful installation in an industrial environment.

1. A unit should be mounted in a metal enclosure, which is properly connected to protective earth.
2. Use shielded cables for all Signal and Control inputs. The shield connection should be made as short as possible. The connection point for the shield depends somewhat upon the application. Listed below are the recommended methods of connecting the shield, in order of their effectiveness.
  - a. Connect the shield to earth ground (protective earth) at one end where the unit is mounted.
  - b. Connect the shield to earth ground at both ends of the cable, usually when the noise source frequency is over 1 MHz.
3. Never run Signal or Control cables in the same conduit or raceway with AC power lines, conductors, feeding motors, solenoids, SCR controls, and heaters, etc. The cables should be run through metal conduit that is properly grounded. This is especially useful in applications where cable runs are long and portable two-way radios are used in close proximity or if the installation is near a commercial radio transmitter. Also, Signal or Control cables within an enclosure should be routed as far away as possible from contactors, control relays, transformers, and other noisy components.
4. Long cable runs are more susceptible to EMI pickup than short cable runs.
5. In extremely high EMI environments, the use of external EMI suppression devices such as Ferrite Suppression Cores for signal and control cables is effective. The following EMI suppression devices (or equivalent) are recommended:
  - Fair-Rite part number 0443167251 (Red Lion Controls #FCOR0000)
  - Line Filters for input power cables:
    - Schaffner # FN2010-1/07 (Red Lion Controls #LFIL0000)
6. To protect relay contacts that control inductive loads and to minimize radiated and conducted noise (EMI), some type of contact protection network is

normally installed across the load, the contacts or both. The most effective location is across the load.

- a. Using a snubber, which is a resistor-capacitor (RC) network or metal oxide varistor (MOV) across an AC inductive load is very effective at reducing EMI and increasing relay contact life.
- b. If a DC inductive load (such as a DC relay coil) is controlled by a transistor switch, care must be taken not to exceed the breakdown voltage of the transistor when the load is switched. One of the most effective ways is to place a diode across the inductive load. Most Red Lion products with solid state outputs have internal zener diode protection. However external diode protection at the load is always a good design practice to limit EMI. Although the use of a snubber or varistor could be used.

Red Lion part numbers: Snubber: SNUB0000

Varistor: ILS11500 or ILS23000

7. Care should be taken when connecting input and output devices to the instrument. When a separate input and output common is provided, they should not be mixed. Therefore a sensor common should NOT be connected to an output common. This would cause EMI on the sensitive input common, which could affect the instrument's operation.

Visit <http://www.redlion.net/emi> for more information on EMI guidelines, Safety and CE issues as they relate to Red Lion products.

## Wiring Connections

All conductors should meet voltage and current ratings for each terminal. Also cabling should conform to appropriate standards of good installation, local codes and regulations. It is recommended that power supplied to the unit (AC or DC) be protected by a fuse or circuit breaker.

After the unit has been mechanically mounted, it is ready to be wired. All wiring connections are made to rear screw terminals. When wiring the unit, use the numbers on the label and those embossed on the back of the case, to identify the position number with the proper function (See page 35, for terminal descriptions). Strip the wire, leaving approximately 1/4" (6 mm) bare wire exposed (stranded wires should be tinned with solder). Insert the wire under the clamping washer and tighten the screw until the wire is clamped tightly.

*Caution: Unused terminals are NOT to be used as tie points. Damage to the timer may result if these terminals are used.*

## **POWER WIRING**

### **AC Versions (C48TXX0X)**

#### **AC Power Wiring**

Primary AC power is connected to terminals 11 and 12, labeled AC. To reduce the chance of noise spikes entering the AC line and affecting the timer, an AC feed separate from that of the load should be used to power the timer. Be certain that the AC power to the timer is relatively “clean” and within the specified range. Connecting power from heavily loaded circuits or circuits that also power loads that cycle on and off, (contacts, relays, motors, etc.) should be avoided.

#### **DC Power Wiring (Non PNP Output models)**

The DC power is connected to terminals 9 & 10, marked COMM. and DC OUT/IN. The DC power source must be capable of supplying the unit’s rated current (150 mA max.) and be within the specified 11 to 14 VDC range. The C48T has non-volatile memory, that stores information on power down, thereby eliminating the need for battery back-up.

*Note: AC versions with PNP outputs cannot be powered from DC.*



*Caution: Observe proper polarity when connecting DC voltages. Damage to the unit will occur if polarity is reversed.*

#### **DC Versions (C48TXX1X)**

DC power (18 to 36 VDC) or low voltage AC power (24 VAC) is connected to terminals 11 and 12, labeled DC+ (AC) and DC- (AC) respectively.

#### **Output Power**

For DC/ Low Voltage units that do not have PNP current sourcing outputs, Terminal 10, DC OUT ( $V_{SRC}$  IN), provides a DC output for sensor power (+12 VDC +/-15%). The maximum sensor current is 100 mA.

For units with PNP current sourcing outputs, this terminal serves a dual purpose depending on the application’s PNP output voltage level and current requirements.

1. The terminal may be used as a +12 VDC output for sensor power. In this case, the PNP output voltage level will be +12 VDC ( $\pm 15\%$ ). A maximum of 100 mA is available for the combination of sensor current and PNP output sourcing current.
2. If a higher PNP output voltage level or additional output sourcing current is desired, an external DC supply may be connected between the “DC OUT ( $V_{SRC}$  IN)” and “COMM.” terminals. This supply will determine the PNP output voltage level, and must be in the range of +13 to +30 VDC.

An external DC supply can also provide the additional output sourcing current required in applications where two or more PNP outputs are “ON” simultaneously. However, the maximum current rating of 100 mA per individual output must not be exceeded, regardless of external supply capacity.

#### **Serial Communications Wiring**

It is recommended that shielded (screened) cable be used for serial communications. This unit meets the EMC specifications using Alpha #2404 cable or equivalent. There are higher grades of shielded cable, such as, four conductor twisted pair, that offer an even higher degree of noise immunity.

Refer to RS-485 Serial Communications, page 24, for wiring and operational procedures.

#### **Run/Stop Input**

The RUN/STOP input can be configured as a current sinking (active low) or current sourcing (active high) input using the User Input plug jumper. The timer will RUN when RUN/STOP (terminal #7) is connected to the active logic level. See chart on Page 8, for active and inactive voltage levels for each User Input plug jumper setting.

In some operating modes, the timer will automatically STOP timing when the main output is triggered. (See Timer Operating Modes in the programming section, Page 13.) In these modes, the RUN/STOP input can be used to restart the timer by momentarily taking the input to the STOP state (inactive logic level) and then back to the RUN state (active logic level). Cycling the RUN/STOP terminal, however, will not reset or affect the output(s).

## User Inputs

The three external user inputs are programmable inputs that can be configured as current sinking (active low) or current sourcing (active high) inputs via a single plug jumper. Programmable external user inputs are digital inputs. The use of shielded cable is recommended. Follow the EMC Installation Guidelines for shield connection. See User Inputs, page 19, for a description of all available user input functions. The active logic state of ALL user inputs is dictated by the position of the User Input plug jumper. The plug jumper is located on the CPU board (See Figure 9, User Input and Program Disable Jumper Locations).

User Input State	Input Voltage Level for Jumper Position	
	Source	Sink *
Active	$V_{in} > 3.5 \text{ VDC}$	$V_{in} < 1.5 \text{ VDC}$
Inactive	$V_{in} < 1.5 \text{ VDC}$	$V_{in} > 3.5 \text{ VDC}$

\* Factory Setting

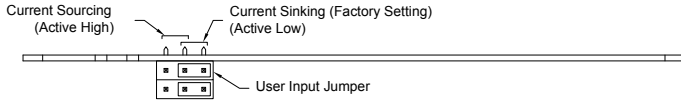

Figure 7, User Input Jumper Settings

## OUTPUT WIRING Relay Connections

To prolong contact life and suppress electrical noise interference due to the switching of inductive loads, it is good installation practice to install a snubber across the contactor. Follow the manufacturer's instructions for installation.

*Note: Snubber leakage current can cause some electro-mechanical devices to be held ON.*

## Program Disable Plug Jumper

The program disable plug jumper is used to enable and disable front panel programming of the C48T. See Front Panel Accessible Functions With Program Disable, page 11, for a description of available functions. The plug jumper is located on the CPU board (See Figure 9, User Input and Program Disable Jumper Locations).

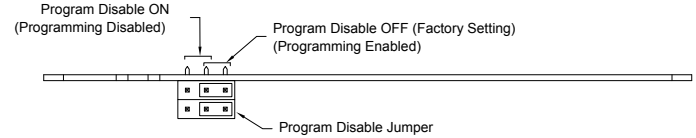

Figure 8, Program Disable Jumper Settings

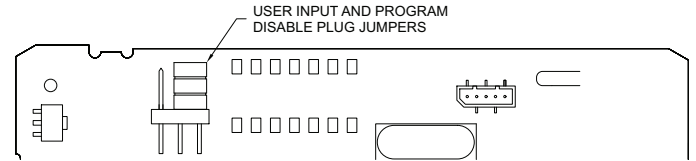

Figure 9, User Input and Program Disable Jumper Locations

## FRONT PANEL DESCRIPTION

The front panel bezel material is flame and scratch resistant, textured plastic with clear viewing window that meets NEMA 4X/IP65 requirements, when properly installed. Continuous exposure to direct sunlight might accelerate the aging process of the plastic material used in the bezel. The bezel should be cleaned only with a soft cloth and neutral soap product. Do NOT use solvents.

The display is a dual line, 6 digit LCD. On units with backlighting, the upper Main Display is red and the lower Secondary Display is green.

There are up to five annunciators available in the lower display that illuminate to inform the operator of the timer and output status. See Figure 10, Front Panel, for a description of the annunciators.

Four front panel keys are used to access different modes and parameters. The following is a description of each key.

*Do not use tools of any kind (screwdrivers, pens, pencils, etc.) to operate the keypad of this unit.*

## Keypad Functions

 - This key is a user programmable key. When the key is pressed, the unit performs the appropriate function as programmed. The RST printing on this key is used as a quick reference for the operator if the function key is selected for a reset function.

 - This key is used to access programming, enter changes to data values, and scroll through the available parameters in any mode.

 - This key selects the next available mode option during programming. When programming a numerical value in digit entry mode, this key is used to increment the selected digit position. In auto scrolling entry mode, it increments the value. When in the operating mode, this key is pressed to allow changing of the data value viewed in the secondary display.

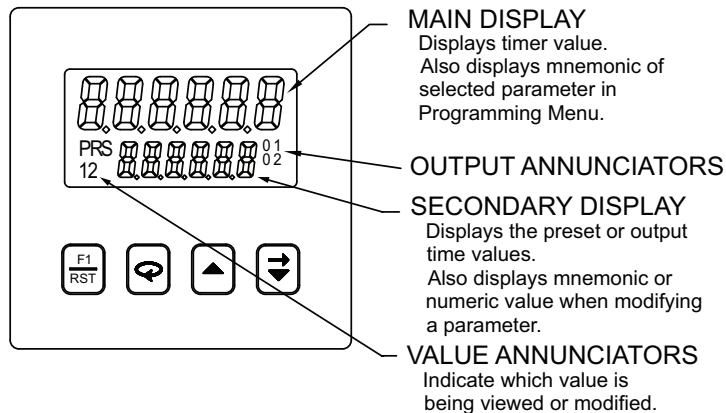



Figure 10 , Front Panel

 - When programming a numerical value in digit entry mode, this key accesses the value and selects the digit to the right. In auto scrolling entry mode, it decrements the value. When in the operating mode, this key is pressed to allow changing of the data value viewed in the secondary display.

# BASIC OPERATION

## Normal Operating Mode

In the normal operating mode, the timer value is shown on the main display. By successively pressing the key, the accessible presets or output time values can be viewed in the secondary display.

Each of these values can be independently programmed to be viewable only, viewable and changeable, or locked (not viewable) in the normal operating mode. If all values are locked, the secondary display will be blank. Only from the normal operating mode can access be gained to the Programming Menu or Protected Value Menu.

## Modifying A Secondary Display Parameter From the Front Panel

Secondary display parameters can be modified from the normal operating mode if the Operator Access privileges allow it.

To modify a parameter, it must be viewed in the secondary display. When the parameter to be modified is viewed, press the or key. Leading zeros appear and the least significant digit blinks. The value can now be modified as described in Programming Numeric Data Values, page 12.

## Protected Value Menu

The Protected Value Menu allows access to selected presets and output time values without having them viewable or changeable from the main display. To enter the protected menu, the key is pressed and held, and a code value is entered. The Protected Value Menu and the Programming Menu are not available at the same time. See Front Panel Accessible Functions With Program Disable, page 11, for available options.

Access value parameters that are programmed for “P” or “n” are accessible in the Protected Value Menu. Parameters selected as “n” (no) are viewable from the main display, but can only be changed in the protected menu. Parameters selected as “P” (protected) are not viewable from the main display, but can be viewed and changed in the protected menu.

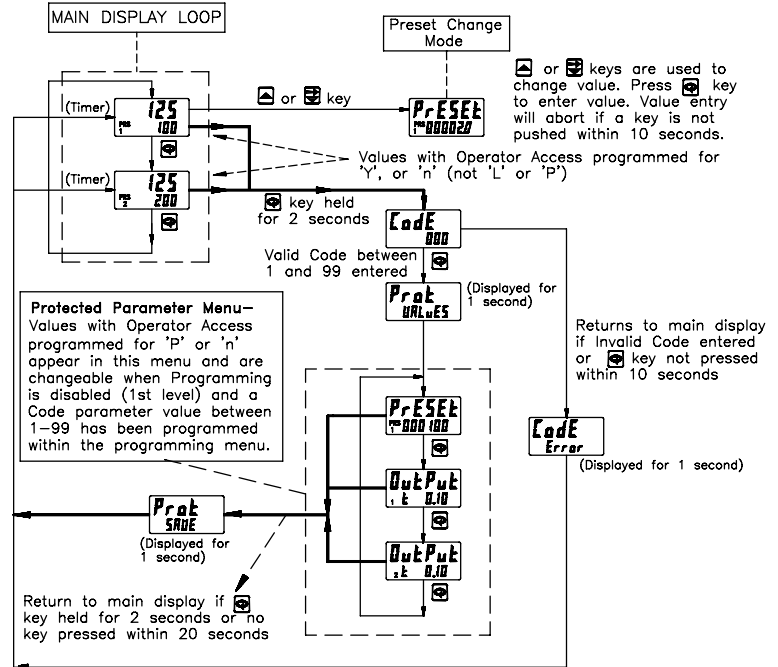

Figure 11, Protected Value Menu



## Front Panel Accessible Functions With Program Disable







There are several ways to limit the programming of parameters from the front panel keypad. The Accessible Value parameter is used with the Program Disable plug jumper and an external programmable User Input selected for *Pr od 15* to limit programming. To enter the programming mode, a code number may need

to be entered, depending on the Program Disable Setting. Front Panel Function Key F1 cannot be selected for program disable. The following table describes the possible program disabling functions.





PGM.DIS. JUMPER	USER INPUT TERMINAL	PROGRAM CODE NUMBER	PROTECTED VALUE MENU	OPERATOR ACCESS AT MAIN DISPLAY	PROGRAMMING ENABLED	PROGRAM DISABLE LEVEL
OFF (EN)	INACTIVE or Not Programmed for Pro.dis	ALL	No	All displayed values changeable	Yes	None
OFF (EN)	ACTIVE	0	No	Per Access Privileges programmed	No	Level 1
OFF (EN)	ACTIVE	1 to 99	Yes W/code	Per Access Privileges programmed	No	Level 1
OFF (EN)	ACTIVE	100 to 199	No	Per Access Privileges programmed	Yes W/code	Level 1
ON (DIS)	INACTIVE or Not Programmed for Pro.dis	0	No	Per Access Privileges programmed	No	Level 1
ON (DIS)	INACTIVE or Not Programmed for Pro.dis	1 to 99	Yes W/code	Per Access Privileges programmed	No	Level 1
ON (DIS)	INACTIVE or Not Programmed for Pro.dis	100 to 199	No	Per Access Privileges programmed	Yes W/code	Level 1
ON (DIS)	ACTIVE	ALL	No	Viewable only	No	Level 2

# PROGRAMMING GENERAL DESCRIPTION

Programming of the C48T is done through the front panel keypad. English language prompts, flashing parameter values, and the front panel keypad aid the operator during programming.



Although the unit has been programmed at the factory, the parameters generally have to be changed to suit the desired application. In order to access the Programming Menu, the Program Disable jumper and/or any User Input programmed for *Prod 15* may need to be turned off or deactivated. When shipped from the factory, all programming is enabled. See Front Panel Accessible Functions With Program Disable, page 11, for program disabling options. With programming enabled, to enter the programming menu, the  key is pressed and held for two seconds. Once in the programming menu, the  key is used to sequence through the list of programming parameters. To loop backwards one item in the Programming Menu, press and hold the  key, then quickly press and hold the  key while releasing the  key. Repeatedly pressing the  key with the  key held will continue the backwards sequencing.

## Programming Option Values



The operator can scroll through the available options for a selected parameter by pressing the  or  key to enter parameter change mode, and then pressing the  key repeatedly until the desired option is viewed. The option is entered by pressing the  key, which returns the operator to the Programming Menu.

## Programming Numeric Data Values



The Presets and output time values may be accessible when the unit is in the normal operating mode (not programming mode), providing that the Program Disable input is not activated. Pressing the  key will sequence the secondary display through the available presets and output time values.

To change a numeric data value, it must be visible on the secondary display. Pressing the  or  key will allow changing of the value. The two methods for changing numeric data values are “digit entry” and “auto scrolling”.





## Digit Entry

If the preset entry method has been set to “digit entry”, the least significant digit will blink. Pressing the  key multiple times will select other digits. Pressing the  key will increment the selected digit. The data value will be entered when the  key is pushed, or the old value will be retained if no key activity is detected for 10 seconds.





## Short-Cut - Decrementing Value

To decrement a digit value, press and hold the  key and then press the  key. This will decrement the selected digit to zero if held.

## Auto Scrolling

If the data entry method is set to “auto scrolling”, the data value can be progressively changed by pressing and holding the  or  keys. If one of the keys is pushed and held, the value will scroll automatically. After 5 counts, the unit enters fast scroll mode. If a key remains pushed, a digit shift occurs every one hundred counts until the maximum value or zero is reached. When the digit shift occurs, the previously scrolling digit goes to zero. When scrolling at the higher order digit locations, you can switch directions by quickly pressing the other key ( or ) within a second following the release of previous direction key.

## Short-Cut - Quick Digit Shift

To quickly select higher order digits while incrementing or decrementing numeric values (with  or  held), press and hold the  key. This sequences the selected digit from the least to the most significant digit. As each digit is passed, it changes to zero. When the desired digit is reached, release the  key to increment or decrement from the new digit location.

## Saving Program

All parameter values changed in programming mode are saved when exiting. To exit programming mode, press and hold the  key for two seconds. The display will momentarily display *Prog SAVE* while the parameter values are saved in non-volatile memory. The unit then returns to the indication display that was last viewed.

# USER INTERFACE/PROGRAMMING MODES

The operating modes of the C48T are programmed using the front panel keypad. (See page 12, for details on using the keypad to program the unit) Accessibility to the Programming Menu depends on the Program Disable Function setting (See page 11, for available program disable settings).

## PROGRAMMING MENU



### Numeric Value Entry Method

Configures push button response for entering numeric data values such as Presets and Output Times

MODE	DESCRIPTION
<i>AutoSc</i>	The auto scrolling method allows pressing and holding the “up” or “down” keys to progressively change all digits of the data value, similar to incrementing or decrementing a counter.
<i>digit</i>	The digit entry method allows the selecting and incrementing of each numeric digit on an individual digit-by-digit basis.



### Timer Range

The timer range determines the time units to be used.

MODE	RANGE	RESOLUTION
<i>SEC.000</i>	999.999 Seconds	0.001 sec
<i>SEC.00</i>	9999.99 Seconds	0.01 sec
<i>SEC.0</i>	999999.9 Seconds	0.1 sec
<i>SEC</i>	9999999 Seconds	1 sec
<i>m.000</i>	999.999 Minutes	0.001 min
<i>m.00</i>	9999.99 Minutes	0.01 min
<i>m.0</i>	999999.9 Minutes	0.1 min
<i>mSEC</i>	9999.59 Minutes.Seconds	1 sec
<i>mSEC.0</i>	999.59.9 Minutes.Seconds.0	0.1 sec
<i>hmSEC</i>	99.59.59 Hours.Minutes.Seconds	1 sec
<i>hm.00</i>	99.59.99 Hours.Minutes.00	0.01 min
<i>hm.0</i>	999.59.9 Hours.Minutes.0	0.1 min
<i>hm</i>	9999.59 Hours.Minutes	1 min
<i>h.00</i>	9999.99 Hours	0.01 hr
<i>h.0</i>	99999.9 Hours	0.1 hr
<i>h</i>	999999 Hours	1 hour



### Timer Operating Mode

The charts on the following pages, show operating modes for the Single Preset and Dual Preset Timer Models. In the descriptions below, the “Main Preset” or “Output” refers to “Preset 1” or “Output 1” on the Single Preset Model. On the Dual Preset Model it refers to “Preset 2” or “Output 2”.

#### Reset Type:

- Auto** - Unit automatically resets as programmed, when timer triggers main preset’s output or at it’s timed output end.
- Manual** - Unit does not reset when timer triggers main preset’s output or at it’s timed output end. The timer value can be manually reset by a User Input or by Serial Communications command.

#### Reset to:

- Zero** - When reset (manually or automatically) timer value goes to zero. The Main Preset Output is triggered when timer value reaches main Preset Value.
- Preset** - When reset (manually or automatically), the main Preset value is loaded into the timer value. The main Preset Output is triggered when timer value reaches zero.

#### At Timed Output End:

When this mode is selected, Auto Reset occurs when the main preset’s Output time elapses and the main output deactivates. If not selected, Auto reset occurs when the main output is triggered.

#### Continue Timing at Main Output:

The timer continues timing when main output is triggered. To stop timing, the “Run/Stop” terminal is put into the “Stop” state. This mode is useful for repetitive, auto-cycling applications.

#### Stop Timing at Main Output:

The timer will stop when the main preset’s output is triggered. To resume timing, a manual reset (User Input - **rSt-E**) is performed, which resets the output and the stop condition. The Run/Stop input can also be used to restart the timer by putting it in the “Stop” state and then back to the “Run” state. Cycling the Run/Stop however, will not reset or affect any outputs. This mode is used to provide “one-shot” capability.

### Output 1: (Main Output for Single Preset Model)

**Latched** - When Output 1 activates it stays activated or latched until it is manually reset.

**Timed** - When Output 1 is activated it stays activated for the time specified by the Output 1 Time Value. Output 1 deactivates after the Output 1 time elapses.

### O1 Off at O2: (Dual Preset only)

Output 1 activates at Preset 1. It deactivates when Output 2 is activated. (Does not apply to activation from Serial command.)

### Output 2: (Dual Preset Model only; Main Output)

Operates similarly to Output 1 Latched and Timed modes.

### SINGLE PRESET OPERATING MODES

Use either of the two charts on this page for more information on specific operating modes.

SINGLE PRESET OPERATING MODES	
1	- Continue Timing at 01, Manual Reset to Zero, Latched Output
2	- Continue Timing at 01, Manual Reset to Zero, Timed Output
3	- Continue Timing at 01, Manual Reset to Preset 1, Latched Output
4	- Continue Timing at 01, Manual Reset to Preset 1, Timed Output
5	- Continue Timing at 01, Auto Reset to Zero, Timed Output
6	- Continue Timing at 01, Auto Reset to Preset 1, Timed Output
7	- Continue Timing at 01, Auto Reset to Zero at 01 End, Timed Output
8	- Continue Timing at 01, Auto Reset to Preset 1 at 01 End, Timed Output
9	- Stop Timing at 01, Manual Reset to Zero, Latched Output
10	- Stop Timing at 01, Manual Reset to Zero, Timed Output
11	- Stop Timing at 01, Manual Reset to Preset 1, Latched Output
12	- Stop Timing at 01, Manual Reset to Preset 1, Timed Output
13	- Stop Timing at 01, Auto Reset to Zero, Latched Output
14	- Stop Timing at 01, Auto Reset to Zero, Timed Output
15	- Stop Timing at 01, Auto Reset to Preset 1, Latched Output
16	- Stop Timing at 01, Auto Reset to Preset 1, Timed Output
17	- Stop Timing at 01, Auto Reset to Zero at 01 End, Timed Output
18	- Stop Timing at 01, Auto Reset to Preset 1 at 01 End, Timed Output

MODE#	CONTINUE Timing at 01	STOP Timing at 01	RESET TYPE		RESET			OUTPUT 1	
			Manual	Auto	To Zero	To Preset 1	at Timed Output End	Latched	Timed
1	✓		✓		✓			✓	
2	✓		✓		✓				✓
3	✓		✓			✓		✓	
4	✓		✓			✓			✓
5	✓			✓	✓				✓
6	✓			✓		✓			✓
7	✓			✓	✓		✓		✓
8	✓			✓		✓	✓		✓
9		✓	✓		✓			✓	
10		✓	✓		✓				✓
11		✓	✓			✓		✓	
12		✓	✓			✓			✓
13		✓		✓	✓			✓	
14		✓		✓	✓				✓
15		✓		✓		✓		✓	
16		✓		✓		✓			✓
17		✓		✓	✓		✓		✓
18		✓		✓		✓	✓		✓

## DUAL PRESET OPERATING MODES

Use either of the two charts on the next two pages for more information on specific operating modes.

DUAL PRESET OPERATING MODES	
1	- Continue Timing at 02, Manual Reset to Zero, Latched Outputs
2	- Continue Timing at 02, Manual Reset to Zero, 01 Timed, 02 Latched
3	- Continue Timing at 02, Manual Reset to Zero, 01 and 02 Timed
4	- Continue Timing at 02, Manual Reset to Zero, 01 off at 02, 02 Latched
5	- Continue Timing at 02, Manual Reset to Zero, 01 off at 02, 02 Timed
6	- Continue Timing at 02, Manual Reset to Preset 2, Latched Outputs
7	- Continue Timing at 02, Manual Reset to Preset 2, 01 Timed, 02 Latched
8	- Continue Timing at 02, Manual Reset to Preset 2, 01 and 02 Timed
9	- Continue Timing at 02, Manual Reset to Preset 2, 01 off at 02, 02 Latched
10	- Continue Timing at 02, Manual Reset to Preset 2, 01 off at 02, 02 Timed
11	- Continue Timing at 02, Auto Reset to Zero, 01 and 02 Timed
12	- Continue Timing at 02, Auto Reset to Zero, 01 off at 02, 02 Timed
13	- Continue Timing at 02, Auto Reset to Preset 2, 01 and 02 Timed
14	- Continue Timing at 02, Auto Reset to Preset 2, 01 off at 02, 02 Timed
15	- Continue Timing at 02, Auto Reset to Zero at 02 End, 01 and 02 Timed
16	- Continue Timing at 02, Auto Reset to Zero at 02 End, 01 off at 02, 02 Timed
17	- Continue Timing at 02, Auto Reset to Preset 2 at 02 End, 01 and 02 Timed
18	- Continue Timing at 02, Auto Reset to Preset 2 at 02 End, 01 off at 02, 02 Timed

MODE#	Dual Preset Modes	CONTINUE Timing at 02	RESET TYPE		RESET			OUTPUT 1			OUTPUT 2	
			Manual	Auto	To Zero	To Preset 2	at Timed Output 2 End	Latched	Timed	01 off at 02	Latched	Timed
1		✓			✓			✓			✓	
2		✓	✓		✓				✓		✓	
3		✓	✓		✓				✓			✓
4		✓	✓		✓					✓	✓	
5		✓	✓		✓					✓		✓
6		✓	✓			✓		✓			✓	
7		✓	✓			✓			✓		✓	
8		✓	✓			✓			✓			✓
9		✓	✓			✓				✓	✓	
10		✓	✓			✓				✓		✓
11		✓		✓	✓				✓			✓
12		✓		✓	✓					✓		✓
13		✓		✓		✓			✓			✓
14		✓		✓		✓				✓		✓
15		✓		✓	✓		✓		✓			✓
16		✓		✓	✓		✓			✓		✓
17		✓		✓		✓	✓		✓			✓
18		✓		✓		✓	✓			✓		✓

DUAL PRESET OPERATING MODES	
19	- Stop Timing at 02, Manual Reset to Zero, Latched Outputs
20	- Stop Timing at 02, Manual Reset to Zero, 01 Timed, 02 Latched
21	- Stop Timing at 02, Manual Reset to Zero, 01 and 02 Timed
22	- Stop Timing at 02, Manual Reset to Zero, 01 off at 02, 02 Latched
23	- Stop Timing at 02, Manual Reset to Zero, 01 off at 02, 02 Timed
24	- Stop Timing at 02, Manual Reset to Preset 2, Latched Outputs
25	- Stop Timing at 02, Manual Reset to Preset 2, 01 Timed, 02 Latched
26	- Stop Timing at 02, Manual Reset to Preset 2, 01 and 02 Timed
27	- Stop Timing at 02, Manual Reset to Preset 2, 01 off at 02, 02 Latched
28	- Stop Timing at 02, Manual Reset to Preset 2, 01 off at 02, 02 Timed
29	- Stop Timing at 02, Auto Reset to Zero, Latched Outputs
30	- Stop Timing at 02, Auto Reset to Zero, 01 Timed, 02 Latched
31	- Stop Timing at 02, Auto Reset to Zero, 01 and 02 Timed
32	- Stop Timing at 02, Auto Reset to Zero, 01 off at 02, 02 Latched
33	- Stop Timing at 02, Auto Reset to Zero, 01 off at 02, 02 Timed
34	- Stop Timing at 02, Auto Reset to Preset 2, Latched Outputs
35	- Stop Timing at 02, Auto Reset to Preset 2, 01 Timed, 02 Latched
36	- Stop Timing at 02, Auto Reset to Preset 2, 01 and 02 Timed
37	- Stop Timing at 02, Auto Reset to Preset 2, 01 off at 02, 02 Latched
38	- Stop Timing at 02, Auto Reset to Preset 2, 01 off at 02, 02 Timed
39	- Stop Timing at 02, Auto Reset to Zero at 02 End, 01 and 02 Timed
40	- Stop Timing at 02, Auto Reset to Zero at 02 End, 01 off at 02, 02 Timed
41	- Stop Timing at 02, Auto Reset to Preset 2 at 02 End, 01 and 02 Timed
42	- Stop Timing at 02, Auto Reset to Preset 2 at 02 End, 01 off at 02, 02 Timed

MODE#	STOP Timing at 02	RESET TYPE		RESET			OUTPUT 1		OUTPUT 2		
		Manual	Auto	To Zero	To Preset 2	at Timed Output 2 End	Latched	Timed	01 off at 02	Latched	Timed
19	✓	✓		✓			✓			✓	
20	✓	✓		✓				✓		✓	
21	✓	✓		✓				✓			✓
22	✓	✓		✓					✓	✓	
23	✓	✓		✓					✓		✓
24	✓	✓			✓		✓			✓	
25	✓	✓			✓			✓		✓	
26	✓	✓			✓			✓			✓
27	✓	✓			✓				✓	✓	
28	✓	✓			✓				✓		✓
29	✓		✓	✓			✓			✓	
30	✓		✓	✓				✓		✓	
31	✓		✓	✓				✓			✓
32	✓		✓	✓					✓	✓	
33	✓		✓	✓					✓		✓
34	✓		✓		✓		✓			✓	
35	✓		✓		✓			✓		✓	
36	✓		✓		✓			✓			✓
37	✓		✓		✓				✓	✓	
38	✓		✓		✓				✓		✓
39	✓		✓			✓		✓			✓
40	✓		✓	✓		✓			✓		✓
41	✓		✓		✓	✓		✓			✓
42	✓		✓		✓	✓			✓		✓



## Timer Reset at Power-up

This parameter determines whether or not the timer is reset when power is applied to the unit.

MODE	DESCRIPTION
no	Timer is not reset at power-up. The timer value saved at the previous power-down is restored to the display.
YES	Timer is reset at power-up.

Single Preset Model

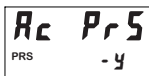

-OR-

Dual Preset Model

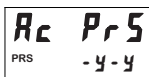

## Access Preset Values

This parameter configures the type of access given to each Preset Value when in normal operating mode and at Program Disable Level 1. The accessibility of each Preset can be individually configured. For more information on Program Disable, see Front Panel Accessible Functions With Program Disable, page 11.

MODE	DESCRIPTION
-L	<b>Locked;</b> Preset is not viewable at main display or in Protected Value Menu. The Preset can only be viewed or changed in the Programming Menu.
-P	<b>Protected Value;</b> Preset value is viewable and changeable in Protected Value Menu only. It is not viewable at Main Display.
-n	<b>No;</b> Preset value is viewable only and not changeable from main display when Programming is Disabled. Value is viewable and changeable in Protected Value Menu.
-y	<b>Yes;</b> Preset value is viewable and changeable at main display when at 1st level program disable. Value is not shown in Protected Value Menu.

## Programming Keys:

- Selects Preset Value being configured as indicated by the number on the left side of the bottom display line.

- Changes mode selection for selected Preset.



## Preset 1 Value

The Preset 1 value is used to control the activation of Output 1.

Dual Preset Model



## Preset 2 Value (Dual Preset Model only)

The Preset 2 value is used to control the activation of Output 2.

Dual Preset Model



## Preset 1 Track Preset 2 (Dual Preset Model only)

This parameter configures whether or not the Preset 1 value tracks or follows the Preset 2 value.

MODE	DESCRIPTION
no	Preset 1 does not track Preset 2
YES	Preset 1 tracks Preset 2 value. When Preset 2 value is changed, the Preset 1 value will change to maintain the same offset. Changing Preset 1 will modify the offset.

Single Preset Model



-OR-

Dual Preset Model



## Access Output Time Values

This parameter configures the type of access given to each Output Time Value when in normal operating mode and at Program Disable Level 1. The accessibility of each Output Time Value can be individually configured.

For more details on Program Disable, see the Front Panel Accessible Functions With Program Disable, page 11.

MODE	DESCRIPTION
-L	<b>Locked;</b> Output Time Value is not viewable at main display or in Protected Value Menu. The Output Time Value can only be viewed or changed in the Programming Menu.
-P	<b>Protected Value;</b> Output Time Value is viewable and changeable in Protected Value Menu only. It is not viewable at Main Display.
-n	<b>No;</b> Output Time Value is viewable only and not changeable from main display when Programming is Disabled. Value is viewable and changeable in Protected Value Menu.
-y	<b>Yes;</b> Output Time Value is viewable and changeable at main display when at 1st level program disable. Value is not shown in Protected Value Menu.

### Programming Keys:

- Selects Output Time Value being configured as indicated by the number on the left of the bottom display.
- Changes mode selection for selected Output Time Value.

## Output Resolution

This parameter configures the timed output resolution for all available Outputs. Use the **0.0 1SEC** resolution if all Output Time Values are below 99.99 seconds.

MODE	DESCRIPTION
<b>0.0 1SEC</b>	0.01 Second Output Resolution; Maximum Output time: 99.99 Seconds
<b>0.1 SEC</b>	0.1 Second Output Resolution; Maximum Output time: 999.9 Seconds



Dual Preset Model



Single Preset Model



-OR-

Dual Preset Model



## Output 1 Time Value

The Output 1 Time Value controls the Output 1 duration, when Output 1 is set for timed mode of operation (**OPER** parameter). The Output time value range will be 0.01-99.99 Seconds or 0.1-999.9 seconds, depending on the setting of the Output Resolution (**OutRES**) parameter.

## Output 2 Time Value (Dual Preset Model only)

The Output 2 Time Value controls the Output 2 duration, when Output 2 is set for timed mode of operation (**OPER** parameter). The Output time value range will be 0.01-99.99 Seconds or 0.1-999.9 seconds, depending on the setting of the Output Resolution (**OutRES**) parameter.

## Reverse Output Logic

This parameter individually configures whether or not the Output Logic is reversed, for all Preset Outputs.

MODE	DESCRIPTION
-n	<b>No;</b> Output Logic is not Reversed. Output / Relay will turn ON at Preset Value or Zero (Reset to Preset modes) and turn OFF when Reset or Output Time expires.
-y	<b>Yes;</b> Output Logic is Reversed. Output / Relay will turn OFF at Preset Value or Zero (Reset to Preset modes) and turn ON when Reset or Output Time expires.

### Programming Keys:

- Selects Output being configured as indicated by the number on the left of the bottom display line.
- Selects Output Logic mode for selected Output.



Single Preset Model



-OR-

Dual Preset Model



Single Preset Model



-OR-

Dual Preset Model

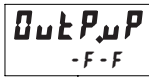

## Reverse Annunciator Logic

This parameter controls the logic state of the Output Display Annunciators ('01' and '02').

MODE	DESCRIPTION
-n	<b>No;</b> Output Annunciator Logic is not Reversed. Output Annunciator will be ON when the Output is ON.
-y	<b>Yes;</b> Output Annunciator Logic is Reversed. Output Annunciator will be ON when the Output is OFF.

### Programming Keys:

- Selects Output Annunciator being configured as indicated by the number on the left side of the bottom display line.
- Selects Output Annunciator Logic for selected Output.

## Output Power-Up State

This parameter controls the Power-Up State of the Outputs.

MODE	DESCRIPTION
-F	<b>Off;</b> The output will be off at power-up.
-0	<b>On;</b> The output will turn on at power-up.
-P	<b>Previous State;</b> For latched output modes only. The output will power-up in the state it was in at power-down. For non-latched modes, the output will power-up in the off state.

### Programming Keys:

- Selects Output being configured as indicated by the number on the left side of the bottom display line.
- Selects Output Power-up state for selected Output.

## User Inputs

Three external User Inputs plus the front panel function key are available on the C48 Timer. The parameter list below shows all available user input functions. The Input Pull-Up / Pull-down resistor and Active logic level for all of the User Inputs is configured with the Snk/Src jumper (See page 8).

MODE	DESCRIPTION
StorE	<b>Store;</b> When the user input is activated, the main display will 'freeze' and remain frozen until user input is released. See Note 1.
StR5-L	<b>Store&amp;Reset (Level Active Reset);</b> When the user input is activated, the timer display will freeze and the internal Timer value will reset. The timer value will be frozen and internally held reset as long as the user input is held active. See Notes 1 and 2.
StR5-E	<b>Store&amp;Reset (Edge Triggered Reset);</b> When the user input is activated, the display will freeze and be held until the user input is released. The internal Timer value resets momentarily and then continues to time while the input is held active. If the timer had previously stopped as a result of the timer operating mode (See Timer Operating Mode, page 13), it will restart immediately following the edge triggered reset. See Notes 1 and 2.
r5t. -L	<b>Reset (Level Active);</b> When the user input is activated, the timer value and outputs will be reset and held reset until the user input is released. See Note 2
r5t. -E	<b>Reset (Edge Triggered);</b> When the user input is activated, the timer value and outputs will be momentarily reset and then continue to time and activate while the input is held active. See Note 2
[h]dSP	<b>Change Display (Edge Triggered);</b> When the user input is activated, the secondary display will sequence to the next available value.
Prad 15	<b>Program Disable [Level Active] (not available for F1 Key);</b> See page 10 for details of Program Disable options.
dn-L	<b>Down (Level Active); (User Input 1 only)</b> When User Input 1 is active, the unit will time down. When User Input 1 is inactive, the unit will time up. This mode is normally not necessary, unless the application requires both up and down timing.

MODE	DESCRIPTION
<b>Print</b>	<b>Print Request</b> [Level Active] (RS485 Option only); When the user input is activated, the timer and preset values, as configured in the Print Options ( <b>Print</b> ) parameter, will be continually transmitted on the RS485 terminals. See RS485 Serial Communications, page 24.
<b>Reset</b>	<b>Reset Outputs</b> (Edge Triggered); When the user input is activated, all active outputs will reset to their inactive states. This is a momentary reset.

*Note 1: Only one user input may be programmed for a Store or Store&Reset function.*

*Note 2: If the timer had previously stopped as a result of the timer Operating mode (See Timer Operating Modes, page 13), it will restart following user input release (level active reset modes) or immediately (edge triggered reset modes).*

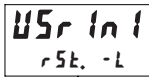

### User Input 1

User Input 1 can be programmed for any of the parameters listed previously.

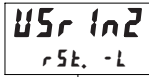

### User Input 2

User Input 2 can be programmed for any of the parameters listed previously, except for down timing.

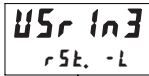

### User Input 3

User Input 3 can be programmed for any of the parameters listed previously, except for down timing.

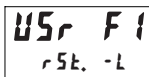

### User F1 Key

User F1 is the front panel function key. This user input can be programmed for any of the parameters listed previously, except for the Program Disable and down timing function.



## Programming/Protected Parameter Menu Code Value (0-199)

The Programming Code value can be used to provide Data Value or Programming Menu security. Depending on the Code range selected and the Program Disable Level, it may be necessary to enter the code value before the unit allows access to Programming Menus or Protected Values. See Front Panel Accessible Functions With Program Disable, page 11, for more information.

CODE VALUE	DESCRIPTION
<b>0</b>	Programming is Disabled and Code entry display is not available when Program is Disabled.
<b>1-99</b>	Protected Parameter Menu appears when Code is entered and Program is Disabled.
<b>100-199</b>	Programming Menu appears when code is entered and Program is Disabled.



## Scroll Display

This parameter configures whether or not the secondary display will scroll or sequence automatically to the next available value.

MODE	DESCRIPTION
<b>no</b>	Disables or turns off display scrolling
<b>YES</b>	Enables display scrolling (2.5 Sec display time)

The next five parameters pertain to serial communications and are only found on Dual Preset units with the RS-485 serial option installed.

**5Er5Et**  
96n

### Serial Baud Rate and Parity Settings

This parameter configures the Baud Rate and Parity Settings for RS485 Serial Communications.

MODE	DESCRIPTION
12n	1200 Baud; No Parity (8 data bits)
12o	1200 Baud; Odd Parity (7 data bits)
12E	1200 Baud; Even Parity (7 data bits)
24n	2400 Baud; No Parity (8 data bits)
24o	2400 Baud; Odd Parity (7 data bits)
24E	2400 Baud; Even Parity (7 data bits)
48n	4800 Baud; No Parity (8 data bits)
48o	4800 Baud; Odd Parity (7 data bits)
48E	4800 Baud; Even Parity (7 data bits)
96n	9600 Baud; No Parity (8 data bits)
96o	9600 Baud; Odd Parity (7 data bits)
96E	9600 Baud; Even Parity (7 data bits)

**5ErAdr**  
0

### Serial Unit Address (00-99)

This parameter configures the Serial Unit Address. This address is used to uniquely identify each unit when multiple units are connected on an RS485 bus.

**PrnOPt**  
3

### Print Options

The Print Options parameter determines which values are printed in response to a Print Request command or user input print request.

MODE NUMBER	PRINT	
	Timer Value	Preset Values
01	√	
02		√
03	√	√

**5ErAbr**  
na

### Serial Abbreviate Mnemonics

When transmitting data, the unit can be programmed to suppress the address number, mnemonics, and some spaces by selecting **YES** for this parameter. A selection of **YES** results in a faster transmission and may be useful when interfacing with a computer. However, when interfacing with a printer, sending mnemonics is usually desirable.

**MODE** DESCRIPTION  
**na** Unit sends Serial Address, Value Mnemonic, and right justified numeric value when a serial Transmit Value command, a Print Request command, or User Input Print Request is issued. A 400 msec "printer delay" is inserted between each value when a Serial Print Request command or User Input Print Request is performed.

**YES** Only the numeric data value is transmitted when a serial Transmit Value command, Print Request command or User Input Print Request is issued. No unit address, mnemonics, or 400 msec printer delay are transmitted. This option is beneficial when communicating with a computer and faster data throughput is desired.

**PrnrSt**  
no

### Print and Reset Timer Value

This parameter is used in conjunction with a Print Request (User Input or Serial Command) and the Print Options to determine whether or not the timer value is reset after the value is acquired for serial transmission.

MODE	DESCRIPTION
no	Do not reset timer value after Print.
YES	The Timer Value, when specified in Print Options will reset after being printed (transmitted on Serial) when a Serial or User Input Print Request is issued.

**FRcSEt**  
no

### Factory Settings

This parameter is used to reset all parameters to their factory defaults. The Factory Settings chart below shows settings for each programming parameter.

MODE	DESCRIPTION
no	Do not reset parameters to Factory Settings.
YES	Reset all programming parameters to their Factory Settings.

### FACTORY SETTINGS CHART\*

<b>Entry</b>	NUMERIC VALUE ENTRY METHOD	<b>RutoSc</b>
<b>trAnGE</b>	TIMER RANGE	<b>SECD</b>
<b>OPER</b>	TIMER OPERATING MODE	<b>11</b>
<b>rStP,uP</b>	TIMER RESET AT POWER-UP	<b>no</b>
<b>PRESETS</b>		<b>2 1</b>
<b>Rc PrS</b>	ACCESS PRESET VALUE	<b>-4-4</b>
<b>PrESEt</b>	PRESET 1 VALUE	<b>10</b>
<b>PrESEt</b>	PRESET 2 VALUE (Dual Preset only)	<b>20</b>
<b>P1trRc</b>	P1 TRACK P2 (Dual Preset only)	<b>no</b>

### OUTPUTS

<b>Rc Out</b>	ACCESS OUTPUT TIME VALUES	<b>-L-L</b>
<b>OutRES</b>	OUTPUT RESOLUTION	<b>001SEC</b>
<b>OutP1t</b>	OUTPUT 1 TIME	<b>0.10</b>
<b>OutP2t</b>	OUTPUT 2 TIME (Dual Preset only)	<b>0.10</b>
<b>rEUOut</b>	REVERSE RELAY/OUTPUT LOGIC	<b>-n-n</b>
<b>rEUAnn</b>	REVERSE ANNUNCIATOR LOGIC	<b>-n-n</b>
<b>OutP,uP</b>	OUTPUT POWER-UP STATE	<b>-F-F</b>

### USER INPUTS

<b>USr In1</b>	USER INPUT 1	<b>rSt, -L</b>
<b>USr In2</b>	USER INPUT 2	<b>rSt, -L</b>
<b>USr In3</b>	USER INPUT 3	<b>rSt, -L</b>
<b>USr F1</b>	USER F1 KEY	<b>rSt, -L</b>

**Code** PROGRAMMING CODE VALUE **0**

**Scroll** SCROLL DISPLAY **no**

### RS-485 SERIAL OPTION (Dual Preset only)

<b>SErSEt</b>	SERIAL BAUD RATE & PARITY	<b>96n</b>
<b>SErAdr</b>	SERIAL UNIT ADDRESS	<b>0</b>
<b>SErAbbr</b>	ABBREVIATE SERIAL MNEMONICS	<b>no</b>
<b>PrnOPT</b>	PRINT OPTIONS	<b>3</b>
<b>PrnrSt</b>	PRINT & RESET TIMER VALUE	<b>no</b>

\* Settings shown for Dual Preset model. For Single Preset model, changes to Factory Settings are as follows:

<b>OPER</b>	TIMER OPERATING MODE	<b>5</b>
<b>PrESEt</b>	PRESET 1 VALUE	<b>20</b>

## USER SETTINGS CHART

<b>Entry</b>	NUMERIC VALUE ENTRY METHOD	_____
<b>trAnGE</b>	TIMER RANGE	_____
<b>OPEr</b>	TIMER OPERATING MODE	_____
<b>rStP.uP</b>	TIMER RESET AT POWER-UP	_____
<b>PRESETS</b>		2 1
<b>Ac PrS</b>	ACCESS PRESET VALUE	_____
<b>PrESEt</b>	PRESET 1 VALUE	_____
<b>PrESEt</b>	PRESET 2 VALUE (Dual Preset only)	_____
<b>P1trAc</b>	P1 TRACK P2 (Dual Preset only)	_____
<b>OUTPUTS</b>		2 1
<b>Ac Out</b>	ACCESS OUTPUT TIME VALUES	_____
<b>OutRES</b>	OUTPUT RESOLUTION	_____
<b>OutP.uT</b>	OUTPUT 1 TIME	_____
<b>OutP.uT</b>	OUTPUT 2 TIME (Dual Preset only)	_____
<b>rEUOut</b>	REVERSE RELAY/OUTPUT LOGIC	_____
<b>rEUAnn</b>	REVERSE ANNUNCIATOR LOGIC	_____
<b>OutP.uP</b>	OUTPUT POWER-UP STATE	_____

### USER INPUTS

<b>USr In1</b>	USER INPUT 1	_____
<b>USr In2</b>	USER INPUT 2	_____
<b>USr In3</b>	USER INPUT 3	_____
<b>USr F1</b>	USER F1 KEY	_____

**Code** PROGRAMMING CODE VALUE \_\_\_\_\_

**Scroll** SCROLL DISPLAY \_\_\_\_\_

### RS-485 SERIAL OPTION (Dual Preset only)

<b>SErSEt</b>	SERIAL BAUD RATE & PARITY	_____
<b>SErAdr</b>	SERIAL UNIT ADDRESS	_____
<b>SErAbr</b>	ABBREVIATE SERIAL MNEMONICS	_____
<b>PrnOPt</b>	PRINT OPTIONS	_____
<b>PrnrSt</b>	PRINT & RESET TIMER VALUE	_____

## RS-485 SERIAL COMMUNICATIONS

RS-485 communications allows for transmitting and receiving of data over a single pair of wires. This feature can be used for monitoring various values, changing values, and resetting output(s), all from a remote location. Typical devices that are connected to a C48T unit are a printer, a terminal, or a host computer.

The RS-485 differential (balanced) design has good noise immunity and allows for communication distances of up to 4000 feet. Up to 32 units can be connected on a pair of wires and a common. The unit's address can be programmed from 00 to 99.

### Communication Format

The half-duplex communication operation sends data by switching voltage levels on the common pair of wires. Data is received by monitoring the levels and interpreting the codes that were transmitted. After the unit receives a Transmit Command or Print Request, it will wait 100 msec before it will begin transmitting data. In order for data to be interpreted correctly, there must be identical formats and baud rates between the communicating devices. The formats available for the C48T unit are 1 start bit, 7 or 8 data bits, No parity or 1 parity bit (odd or even) and 1 stop bit. The available baud rates are 1200, 2400, 4800, or 9600 baud.

Before serial communication can take place, the unit must be programmed to the same baud rate and parity as the connected equipment. In addition, the loop

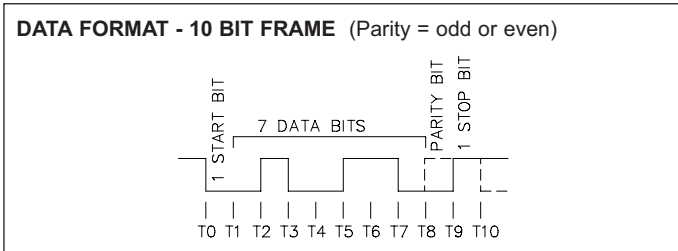

Figure 12, Data Format - 7 Data Bits

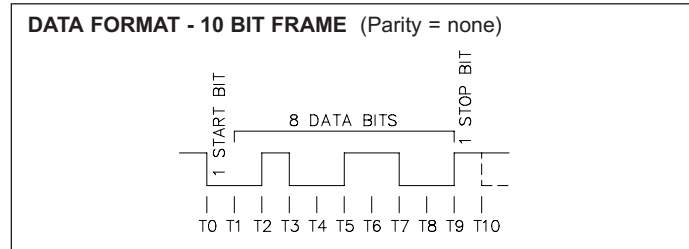

Figure 13, Data Format - 8 Data Bits

address number and print options should be known. When used with a terminal or host computer and only one unit is employed, an address of zero (00) may be used to eliminate the requirement for the address specifier when sending a command. If more than one unit is on the line, assignment of unique non-zero addresses is recommended.

### Sending Commands And Data

When sending commands to the C48T unit, a command string must be constructed. The command string may consist of command codes, value identifiers, and numerical data. Below is a list of commands and value identifiers that are used when communicating with the C48T unit.

COMMAND	DESCRIPTION
N(4EH)	Unit Address; Followed by a one or two digit address number 1-99
P (50H)	Transmit Print Options; Transmits the options selected in the Print Options section of the Programming Menu
R (52H)	Reset value; Followed by one value identifier (E, 1, or 2)
S (53H)	Set value; Followed by one value identifier (1 or 2)
T (54H)	Transmit value; Followed by one value identifier (A, B, or E)
V (56H)	Change value; Followed by one value identifier (A, B or E) then the proper numerical data

VALUE IDENTIFIERS	MNEMONIC
A (41H) Preset 1	P1
B (42H) Preset 2	P2
E (45H) Timer	TMR
1 (31H) Output 1	N/A
2 (32H) Output 2	N/A

*Note: Command identifiers other than those listed should NOT be transmitted. Otherwise, undefined or unpredictable operation could result.*

The command string is constructed by using a command, a value identifier, a data value if required, and the command terminator(\*). The Data value need not contain the decimal point(s) since they are fixed within the C48T, based on the timer range programmed at the front panel. The unit will accept the decimal point(s), however, it does not interpret them in any way. Leading zeros can be eliminated, but all trailing zeros must be present.

Example: If a Preset of 1.000 is to be sent, the data value can be transmitted as 1.000 or 1000. If a “1” is transmitted, the Preset will be changed to 0.001.

The Address command is used to allow a command to be directed to a specific unit on the Serial Communications Line. When the unit address is zero, transmission of the Address command is not required. This is done for applications that do not require more than one unit. For applications that require several units, it is recommended that each unit on the line be given a specific non-zero address. If they are given the same address, a command such as the Transmit Value Command, will cause all of the units to respond simultaneously, resulting in a communication collision. All units in a multiple unit application should be given an address other than zero. If a unit has an address of zero, it will attempt to process any transmissions from the other units as commands. These transmissions fill up the receive buffer of the unit with an address of zero, which may produce unpredictable results.

In a multiple unit configuration, an asterisk (2AH) must be sent to clear the input buffer of all units on the line after a transmit value or print request command is sent to a specific unit on the line. The C48T will require a maximum of 50 msec to process the asterisk (\*).

The command string is constructed in a specific logical sequence. The C48T will not accept command strings that do not follow this sequence. Only one operation can be performed per command string. Below is the procedure to be used when constructing a command string.

1. The first two to three characters of the command string must consist of the Address Command (N) and the address number of the unit (1 thru 99). If the C48T address is zero, the address command and number need NOT be sent.
2. The next character in the command string is the actual command that the unit is to perform (P, R, S, T, or V).
3. A Value Identifier is next if it pertains to the command. The command P (print) does not require a Value Identifier.
4. The numerical data will be next in the command string if the Change Value command (V) is used.
5. All command strings must be terminated with an asterisk \* (2AH). This character indicates to the C48T that the command string is complete.

Below are some typical examples of properly constructed command strings.

**Examples:**

1. Change Preset 1 Value to 123.4 on the C48T with an address of 2.  
COMMAND STRING: N2VA1234\*
2. Transmit the Timer Value of the C48T unit with an address of 3.  
COMMAND STRING: N3TE\*
3. Reset Output 1 of the C48T unit with an address of 0.  
COMMAND STRING: R1\*

If illegal commands or characters are sent to the C48T, the unit will respond by transmitting an error character “E” (45H), in which case the string must be re-transmitted. The C48T will not accept a carriage return or line feed as valid characters.

It is recommended that a “Transmit Value” command follow a “Change Value” Command. If this is done, the reception of the data can provide a timing reference for sending another command and will ensure that the change has occurred. When a “Change Value or Reset Value” command is sent to the C48T, there is time required for the unit to process the command string. The diagrams show the timing considerations that need to be made.

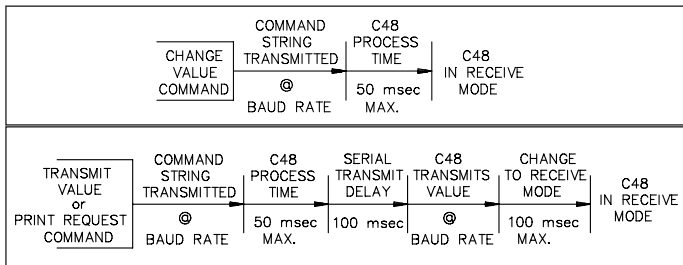

## Receiving Data

Data is transmitted from the C48T when a “T” Transmit Value or a “P” Transmit Print Options command is sent to the unit via the serial port or when a User Input, programmed for the Print Request function, is activated. The C48T will wait a minimum of 100 msec and then begin transmissions. The C48T can also be programmed to transmit mnemonics. The format for a typical transmission string with mnemonics is shown below:

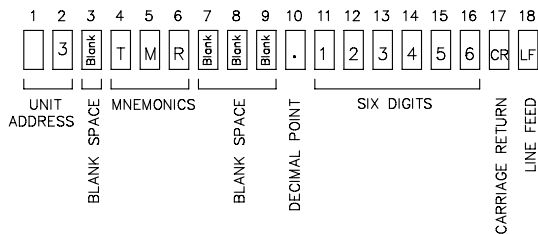

Figure 14, Transmission String

The first two digits transmitted are the unit address followed by one blank space. The next three characters are the mnemonics followed by three or more blank spaces. The numerical data value is transmitted next. The decimal point position will “float” within the data field depending on the actual value it represents. The numeric data is right justified without leading zeros.

When a “T” command or print request is issued, the above character string is sent for each line of a block transmission. An extra <SP><CR><LF> is transmitted following the last line of transmission from a print request, to provide separation between print outs.

If serial is abbreviated (*SErAbr = 4E5*), just numeric data is sent with no time delay. If the C48T transmits mnemonics, there is a 400 msec built-in time delay after each transmission string. When interfacing to a printer, sending mnemonics is usually desirable. Examples of transmissions are shown below:

```
3 P2      6732.5<CR><LF>      Mnemonics Sent
6732.5<CR><LF>      NO Mnemonics Sent
```

The various Print Options are used with a printer or a Computer Terminal. They provide a choice of which C48T data values are to be printed, when either the User Input, programmed for the print request function is activated, or a “P” (Transmit Print Options) command is sent to the C48T via the serial port. See Print Options, page 21, for the available options.

Print outs from a C48T unit with an address of 1 and the following print options are shown below:

	<i>PrrnOPt = 1</i>	<i>PrrnOPt = 2</i>	<i>PrrnOPt = 3</i>
1 TMR	3.45.6	1 P1 3000	1 TMR 3.45.6
		1 P2 6000	1 P1 3000
			1 P2 6000



## **Serial Connections**

When wiring, refer to the numbers listed on the label with the terminal description for installing each wire in its proper location.

For RS-485, the data (transceiver) wires connect to the A(+) and B(-) terminals. It is recommended that shielded (screened) cable be used for serial communications. In some applications, a signal ground may be required to establish a ground reference. The signal ground is required if the equipment does not have internal bias resistors connected to the transceiver lines. If necessary, the shield can be used as the signal ground.

## **TERMINAL DESCRIPTIONS**

COMM. - Common required for communication hook-up.

A (+) & B (-) - The C48T transmits and receives on these two terminals which are connected to the external device.

## **Troubleshooting Serial Communications**

If problems are encountered when interfacing the C48T(s) and host device or printer, the following check list can be used to help find a solution.

1. Check all wiring. Refer to the previous application and use it as a guide to check your serial communication wiring. Proper polarity of all C48T(s) and other peripherals must be observed.
2. If the C48T is connected to a "host computer", device or printer, check to make sure that the computer or device is configured with the same communication format as the C48T. The communication format the C48T will accept is; 1 start bit, 7 or 8 data bits, no parity or 1 parity bit (odd or even), and 1 stop bit.
3. Check the baud rate and parity in the Programming Menu **SErSEt** parameter, and make sure all devices on the line are set to the same baud rate and parity.
4. Check the C48T's unit address. If the Address command is not used when transmitting a command to the C48T, the C48T's address must be set to 0. See Sending Commands & Data, page 24, for command structure.
5. If two-way communications are to be established between the C48T and a computer, have the computer receive transmissions from the C48T first. Activating a User Input, programmed for the print request function, will initiate transmissions from the C48T.
6. When sending commands to the C48T, an asterisk \* (2AH) must terminate the command.
7. In multiple unit configurations, make sure each unit has a different address other than zero. If a transmit value or print request command is issued, an asterisk (\*) must be sent before sending another transmission.
8. If all of the above has been done, try reversing the polarity of the transceiver wires between the C48T (s) and the RS485 interface card. Some cards have the polarity reversed.

## CONNECTING TO A HOST TERMINAL

Six C48T units are used to monitor and control parts packaging machines in a plant. C48T units are located at each machine in the production area of the building. A communication line is run to a PC located in the production office. The drawing shows the line

OFFICE PC  
(WITH RS485 INTERFACE CARD INSTALLED)

connection. Each C48T is programmed for a different address and all are programmed for the same baud rate and parity as the computer (ex. 9600 baud, parity even). An application program is written to send and receive data from the units using the proper commands.

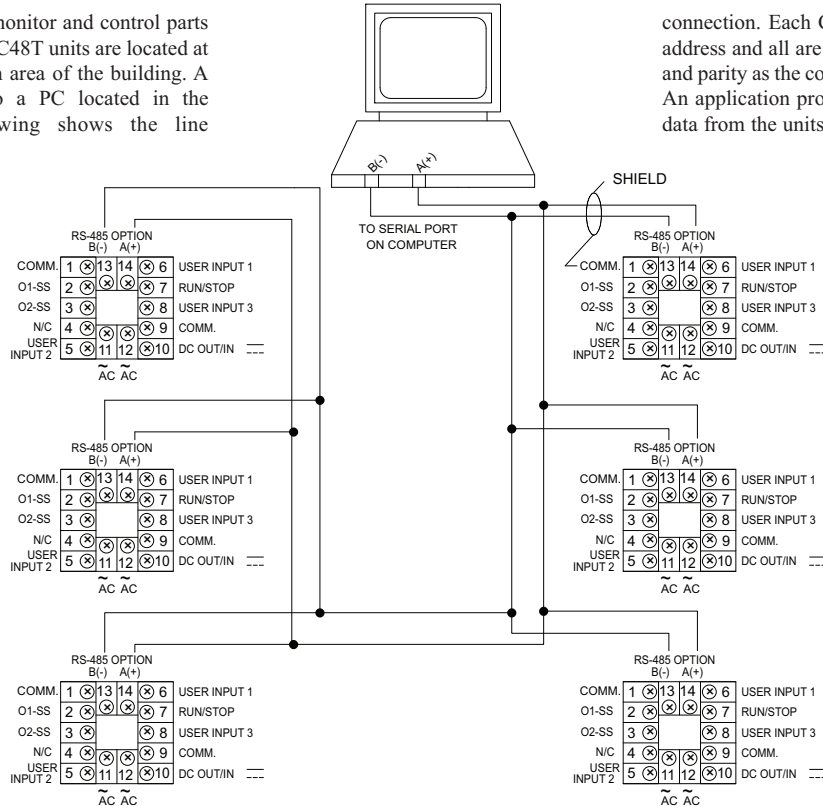

Figure 15, Connecting to a Host Terminal

# APPENDIX "A" - APPLICATION EXAMPLE

## One Shot Timing Cycle

Proper wash down mixture for a food processing plant is an important factor in maintaining the clean environment required. A disinfectant solution is added to the mixing/holding tank used for the wash down cycle. When the holding tank is near empty, a level transducer activates the filler pump. A C48TS is used to turn on the disinfectant solution pump for a preprogrammed amount of time during the filling process of the holding tank.

When the filler pump starts, a momentary contact closure activates User Input 1, resetting the C48 Timer. The timer begins the timing cycle since the run terminal is connected to common. The normally open relay contacts close at the timer reset signal activating the disinfectant solution pump. When the programmed preset is reached, timing stops and the relay deactivates, turning off the pump controlling the disinfectant solution. The C48 Timer's preset cycle time may be changed according to the manufacturer's concentration level of the disinfectant.

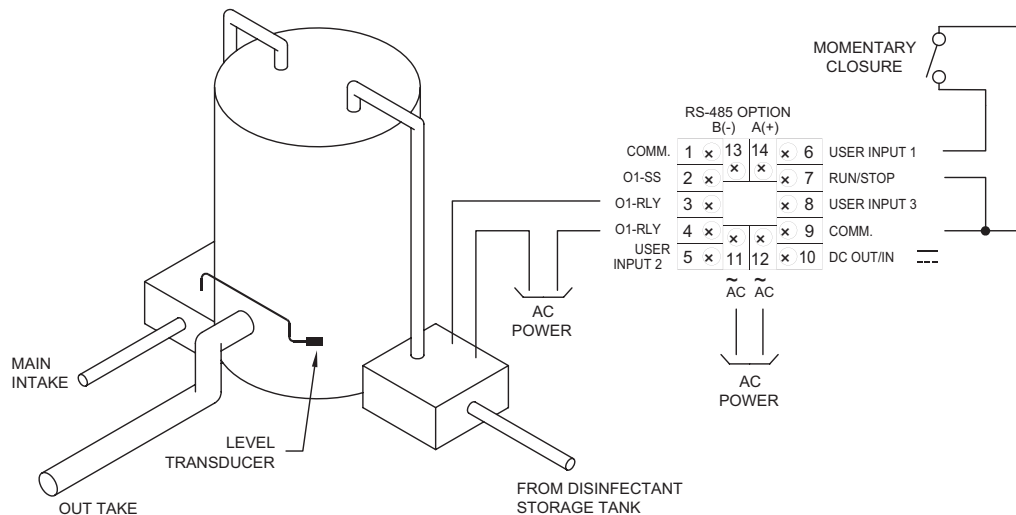

## APPLICATION PROGRAMMING

<b>Entry</b>	<b>AutoSc</b>
<b>ErRNGE</b>	<b>nSEC</b> (min & sec)
<b>OPER</b>	<b>09</b>
<b>rStPwP</b>	<b>no</b>
<b>Rc PrS</b>	<b>-Y</b> (yes)
<b>PrESEt</b>	<b>xxxx.xx</b>
<b>rEUOut</b>	<b>-Y</b> (yes)
<b>rEUAnu</b>	<b>-n</b> (no)
<b>OutPwP</b>	<b>-F</b> (off)
<b>USr In 1</b>	<b>rSt-E</b>
<b>USr In 2</b>	<b>Prad.S</b>
<b>USr In 3</b>	<b>ChgdSP</b>
<b>USr F 1</b>	<b>rSt-E</b>
<b>Code</b>	<b>xxx</b>
<b>Scroll</b>	<b>no</b>

## APPENDIX “B” - SPECIFICATIONS AND DIMENSIONS

1. **DISPLAY:** 2 Line by 6 digit LCD display; Positive image reflective or negative image transmissive with red (top line) and green (bottom line) backlighting.

**Main Display:** 0.3" (7.62 mm) high digits

**Secondary Display:** 0.2" (5.08 mm) high digits

**Annunciators:**

**Value:** PRS, 1, and 2

**Output:** 01 and 02

### 2. POWER REQUIREMENTS:

**AC Versions (C48TXX0X):**

**AC Power:** 85 to 250 VAC, 50/60 Hz, 9 VA max.

**DC Power:** 11 to 14 VDC @ 150 mA max. (Non PNP output models)

*Note: AC Versions with PNP outputs cannot be powered from DC.*

**DC Versions (C48TXX1X):**

**CONTINUOUS:**

**DC Power:** 18 to 36 VDC; 5.5 W max.

**AC Power:** 24 VAC  $\pm 10\%$ ; 50/60 Hz; 7 VA max.

*Note: The +10% tolerance range on AC input voltage must be strictly adhered to. DO NOT EXCEED 26.4 VAC.*

**PEAK (START-UP CURRENT):**

**AC or DC Power:** 500 mA peak start-up current for 10 msec max.

3. **MEMORY:** Nonvolatile E<sup>2</sup>PROM retains all programmable parameters and timer values.

4. **SENSOR POWER:** +12 VDC ( $\pm 15\%$ ) @ 100 mA max.

5. **INPUTS:** Run/Stop, User Input 1, User Input 2, and User Input 3.

Configurable as current sinking (active low) or current sourcing (active high) inputs via a single plug jumper.

**Current Sinking (active low):**  $V_{IL} = 1.5$  VDC max, 22 K $\Omega$  pull-up to 5 VDC.

**Current Sourcing (active high):**  $V_{IH} = 3.5$  VDC min.,  $V_{IN}$  max = 30 VDC; 22 K $\Omega$  pull-down.

**Run/Stop Response Time:** 250  $\mu$ sec max.

**User Input Response Time:** 5 msec max.

6. **TIME ACCURACY:**  $\pm 0.01\%$

7. **OUTPUTS:** (Output type and quantity, model dependent)

**Solid-State:**

**NPN Open Collector:**  $I_{SNK} = 100$  mA max. @  $V_{OL} = 1.1$  VDC max;  $V_{OH} = 30$  VDC max.

**PNP Open Collector:**  $I_{SRC} = 100$  mA max. (See note);  $V_{SRC} = 12$  VDC  $\pm 15\%$  (using internal supply);  $V_{SRC} = 13$  to 30 VDC max. (using external supply).

*Note: The internal supply of the C48T can provide a total of 100 mA for the combination of sensor current and PNP output sourcing current. The supply voltage is +12 VDC ( $\pm 15\%$ ), which will be the PNP output voltage level when using only the internal supply.*

### DIMENSIONS In inches (mm)

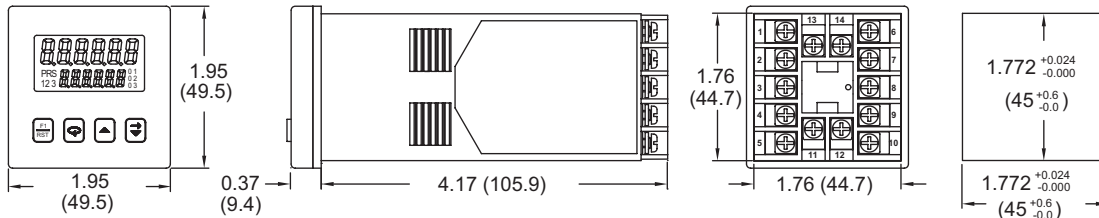

*If additional PNP output sourcing current or a higher output voltage level is desired, an external DC supply may be connected between the “DC Out/In” and “Comm.” terminals. This supply will determine the PNP output voltage level, and must be in the range of +13 to +30 VDC.*

*An external supply can provide the additional output sourcing current required in applications where two or more outputs are “ON” simultaneously. However, the maximum rating of 100 mA per individual output must not be exceeded, regardless of external supply capacity.*

**Relay:** Form A contact, Rating = 5 A @ 250 VAC, 30 VDC (resistive load), 1/10 HP @ 120 VAC (inductive load)

**Relay Life Expectancy:** 100,000 cycles min. at max. load rating

**Programmable Timed Output(s)** User selectable output time resolution:

**0.01 Second Resolution:** 0.01 to 99.99 seconds,  $\pm 0.01\%$  + 10 msec max.

**0.1 Second Resolution:** 0.1 to 999.9 Seconds,  $\pm 0.01\%$  + 100 msec max.

8. **RS485 SERIAL COMMUNICATIONS (Optional):** Up to 32 units can be connected.

**Baud Rate:** Programmable from 1200 to 9600 baud

**Address:** Programmable from 0 to 99

**Data Format:** 10 Bit Frame, 1 start bit, 7 or 8 data bits, 1 or No Parity bit, and 1 stop bit

**Parity:** Programmable for Odd (7 data bits), Even (7 data bits), or None (8 data bits)

9. **ELECTRICAL CONNECTION:** Wire clamping screw terminals.

10. **ENVIRONMENTAL CONDITIONS:**

**Operating Temperature:** 0 to 50°C

**Storage Temperature:** -40 to 70°C

**Vibration to IEC 68-2-6:** Operational 5 to 150 Hz, 2 g.

**Shock to IEC 68-2-27:** Operational 30 g (10 g relay).

**Operating and Storage Humidity:**

85% max. relative humidity (non-condensing) from 0°C to 50°C.

**Altitude:** Up to 2000 meters

11. **CONSTRUCTION:** Black plastic case with collar style panel latch. The panel latch can be installed for horizontal or vertical stacking. Black plastic textured bezel with clear display viewing window. Unit assembly with circuit boards can be removed from the case without removing the case from the panel or disconnecting the wiring. This unit is rated for NEMA 4X/IP65 indoor use. Installation Category II, Pollution Degree 2.

12. **CERTIFICATIONS AND COMPLIANCES:**

**CE Approved**

EN 61326-1 Immunity to Industrial Locations

Emission CISPR 11 Class A

Safety requirements for electrical equipment for measurement, control, and laboratory use:

EN 61010-1: General Requirements

EN 61010-2-030: Particular Requirements for Testing and Measuring Circuits

RoHS Compliant

UL Recognized Component: File #E137808

Type 4X Indoor Enclosure rating (Face only)



IP65 Enclosure rating (Face only)

*Refer to EMC Installation Guidelines section of the manual for additional information.*

13. **WEIGHT:** 6.0 oz (170 g)

## APPENDIX “C” - TROUBLESHOOTING

The majority of problems can be traced to improper connections or incorrect set-up parameters. Be sure all connections are clean and tight, that the correct output board is fitted, and that the set-up parameters are correct. Also, be sure the User Input Plug Jumper position is correct for the particular application. For further technical assistance, contact technical support at [www.redlion.net](http://www.redlion.net).

PROBLEMS	POSSIBLE CAUSE	REMEDIES
NO DISPLAY	<ol style="list-style-type: none"> <li>1. Power off.</li> <li>2. Loose connection or improperly wired.</li> <li>3. Brown out condition.</li> <li>4. Bezel assembly not fully seated into rear of unit.</li> <li>5. If powered by +12 VDC source, not enough current to drive C48.</li> </ol>	<ol style="list-style-type: none"> <li>1. Verify power.</li> <li>2. Check connections and wiring.</li> <li>3. Verify power reading.</li> <li>4. Check installation.</li> <li>5. Verify Source current rating.</li> </ol>
<i>Err 1</i> DISPLAYED AT POWER UP	<ol style="list-style-type: none"> <li>1. Data error in timer value detected by processor.</li> </ol>	<ol style="list-style-type: none"> <li>1. Press  key.</li> <li>2. Check signal lines for possible noise sources.</li> </ol>
<i>Err 2</i> DISPLAYED AT POWER UP	<ol style="list-style-type: none"> <li>1. Data error in preset or output time values detected by processor.</li> </ol>	<ol style="list-style-type: none"> <li>1. Press  key.               <ol style="list-style-type: none"> <li>a. Check presets and output time values.</li> </ol> </li> <li>2. Check signal lines for possible noise sources.</li> </ol>
<i>Err 3</i> DISPLAYED AT POWER UP	<ol style="list-style-type: none"> <li>1. Data error in programming parameters detected by processor.</li> </ol>	<ol style="list-style-type: none"> <li>1. Press  key.               <ol style="list-style-type: none"> <li>a. Check all programming parameters.</li> </ol> </li> <li>2. Check signal lines for possible noise sources.</li> </ol>
UNIT DOES NOT TIME	<ol style="list-style-type: none"> <li>1. Run/Stop input not active.</li> <li>2. Unit programmed for stop timing at output 1 or 2 mode.</li> </ol>	<ol style="list-style-type: none"> <li>1. Check Run/Stop input connections.</li> <li>2. Apply reset to restart the timing cycle.</li> </ol>
CAN NOT ENTER INTO PROGRAMMING	<ol style="list-style-type: none"> <li>1. Front panel disabled.</li> </ol>	<ol style="list-style-type: none"> <li>1. Check “Front Panel Accessible Functions With Program Disable” section of the manual.</li> </ol>

## APPENDIX “C” - TROUBLESHOOTING (Cont’d)

PROBLEMS	POSSIBLE CAUSE	REMEDIES
TIMER WILL NOT RESET WHEN A MANUAL RESET IS PERFORMED	<ol style="list-style-type: none"> <li>1. User input not properly programmed.</li> <li>2. User Input Snk/Src jumper configured improperly.</li> </ol>	<ol style="list-style-type: none"> <li>1. Verify programming of User Input parameter.</li> <li>2. Configure Snk/Src jumper.</li> </ol>
PRESETS OR OUTPUT TIME VALUES CAN BE VIEWED BUT NOT CHANGED	<ol style="list-style-type: none"> <li>1. Front panel disabled.</li> </ol>	<ol style="list-style-type: none"> <li>1. Verify programming of Access presets parameter.</li> <li>2. Check “Front Panel Accessible Functions With Program Disable” section of manual.</li> </ol>
UNIT TIMES WHILE RESET IS ACTIVATED	<ol style="list-style-type: none"> <li>1. User input reset mode set for edge triggered (momentary) reset.</li> </ol>	<ol style="list-style-type: none"> <li>1. Program User input to a level active (maintained) reset.</li> </ol>
OUTPUT WILL NOT RESET	<ol style="list-style-type: none"> <li>1. User input not properly programmed.</li> </ol>	<ol style="list-style-type: none"> <li>1. Verify programming of the user input parameter.</li> </ol>
OUTPUTS NOT WORKING	<ol style="list-style-type: none"> <li>1. Output board not installed.</li> <li>2. Improperly wired.</li> <li>3. Incorrect output board.</li> <li>4. Defective output board.</li> </ol>	<ol style="list-style-type: none"> <li>1. Install output board.</li> <li>2. Check Wiring.</li> <li>3. Check output board.</li> <li>4. Check or replace output board.</li> </ol>

# APPENDIX “D” -TERMINAL CONFIGURATIONS FOR C48 TIMERS



Caution: Observe proper polarity when connecting DC voltages.  
Damage to the unit will occur if polarity is reversed.

## C48TXX0X VERSIONS (85 TO 250 VAC POWERED)

C48TS - SINGLE PRESET RELAY AND SOLID-STATE OUTPUTS		C48TD - DUAL PRESET RELAY OUTPUTS		C48TD - DUAL PRESET SOLID-STATE OUTPUTS																																																																																											
<p>RS-485 OPTION B(-) A(+)</p> <table border="1"> <tr> <td>COMM.</td> <td>1 ⊗</td> <td>13 ⊗</td> <td>14 ⊗</td> <td>6 ⊗</td> <td>USER INPUT 1</td> </tr> <tr> <td>O1-SS</td> <td>2 ⊗</td> <td>⊗</td> <td>⊗</td> <td>7 ⊗</td> <td>RUN/STOP</td> </tr> <tr> <td>O1-RLY</td> <td>3 ⊗</td> <td></td> <td></td> <td>8 ⊗</td> <td>USER INPUT 3</td> </tr> <tr> <td>O1-RLY</td> <td>4 ⊗</td> <td>⊗</td> <td>⊗</td> <td>9 ⊗</td> <td>COMM.</td> </tr> <tr> <td>USER INPUT 2</td> <td>5 ⊗</td> <td>11 ⊗</td> <td>12 ⊗</td> <td>10 ⊗</td> <td>DC OUT/IN ---</td> </tr> </table> <p>~ AC ~ AC</p>		COMM.	1 ⊗	13 ⊗	14 ⊗	6 ⊗	USER INPUT 1	O1-SS	2 ⊗	⊗	⊗	7 ⊗	RUN/STOP	O1-RLY	3 ⊗			8 ⊗	USER INPUT 3	O1-RLY	4 ⊗	⊗	⊗	9 ⊗	COMM.	USER INPUT 2	5 ⊗	11 ⊗	12 ⊗	10 ⊗	DC OUT/IN ---	<p>RS-485 OPTION B(-) A(+)</p> <table border="1"> <tr> <td>O2-RLY</td> <td>1 ⊗</td> <td>13 ⊗</td> <td>14 ⊗</td> <td>6 ⊗</td> <td>USER INPUT 1</td> </tr> <tr> <td>O2-RLY</td> <td>2 ⊗</td> <td>⊗</td> <td>⊗</td> <td>7 ⊗</td> <td>RUN/STOP</td> </tr> <tr> <td>O1-RLY</td> <td>3 ⊗</td> <td></td> <td></td> <td>8 ⊗</td> <td>USER INPUT 3</td> </tr> <tr> <td>O1-RLY</td> <td>4 ⊗</td> <td>⊗</td> <td>⊗</td> <td>9 ⊗</td> <td>COMM.</td> </tr> <tr> <td>USER INPUT 2</td> <td>5 ⊗</td> <td>11 ⊗</td> <td>12 ⊗</td> <td>10 ⊗</td> <td>DC OUT/IN ---</td> </tr> </table> <p>~ AC ~ AC</p>		O2-RLY	1 ⊗	13 ⊗	14 ⊗	6 ⊗	USER INPUT 1	O2-RLY	2 ⊗	⊗	⊗	7 ⊗	RUN/STOP	O1-RLY	3 ⊗			8 ⊗	USER INPUT 3	O1-RLY	4 ⊗	⊗	⊗	9 ⊗	COMM.	USER INPUT 2	5 ⊗	11 ⊗	12 ⊗	10 ⊗	DC OUT/IN ---	<p>RS-485 OPTION B(-) A(+)</p> <table border="1"> <tr> <td>COMM.</td> <td>1 ⊗</td> <td>13 ⊗</td> <td>14 ⊗</td> <td>6 ⊗</td> <td>USER INPUT 1</td> </tr> <tr> <td>O1-SS</td> <td>2 ⊗</td> <td>⊗</td> <td>⊗</td> <td>7 ⊗</td> <td>RUN/STOP</td> </tr> <tr> <td>O2-SS</td> <td>3 ⊗</td> <td></td> <td></td> <td>8 ⊗</td> <td>USER INPUT 3</td> </tr> <tr> <td>N/C</td> <td>4 ⊗</td> <td>⊗</td> <td>⊗</td> <td>9 ⊗</td> <td>COMM.</td> </tr> <tr> <td>USER INPUT 2</td> <td>5 ⊗</td> <td>11 ⊗</td> <td>12 ⊗</td> <td>10 ⊗</td> <td>DC OUT/IN ---</td> </tr> </table> <p>~ AC ~ AC</p>		COMM.	1 ⊗	13 ⊗	14 ⊗	6 ⊗	USER INPUT 1	O1-SS	2 ⊗	⊗	⊗	7 ⊗	RUN/STOP	O2-SS	3 ⊗			8 ⊗	USER INPUT 3	N/C	4 ⊗	⊗	⊗	9 ⊗	COMM.	USER INPUT 2	5 ⊗	11 ⊗	12 ⊗	10 ⊗	DC OUT/IN ---
COMM.	1 ⊗	13 ⊗	14 ⊗	6 ⊗	USER INPUT 1																																																																																										
O1-SS	2 ⊗	⊗	⊗	7 ⊗	RUN/STOP																																																																																										
O1-RLY	3 ⊗			8 ⊗	USER INPUT 3																																																																																										
O1-RLY	4 ⊗	⊗	⊗	9 ⊗	COMM.																																																																																										
USER INPUT 2	5 ⊗	11 ⊗	12 ⊗	10 ⊗	DC OUT/IN ---																																																																																										
O2-RLY	1 ⊗	13 ⊗	14 ⊗	6 ⊗	USER INPUT 1																																																																																										
O2-RLY	2 ⊗	⊗	⊗	7 ⊗	RUN/STOP																																																																																										
O1-RLY	3 ⊗			8 ⊗	USER INPUT 3																																																																																										
O1-RLY	4 ⊗	⊗	⊗	9 ⊗	COMM.																																																																																										
USER INPUT 2	5 ⊗	11 ⊗	12 ⊗	10 ⊗	DC OUT/IN ---																																																																																										
COMM.	1 ⊗	13 ⊗	14 ⊗	6 ⊗	USER INPUT 1																																																																																										
O1-SS	2 ⊗	⊗	⊗	7 ⊗	RUN/STOP																																																																																										
O2-SS	3 ⊗			8 ⊗	USER INPUT 3																																																																																										
N/C	4 ⊗	⊗	⊗	9 ⊗	COMM.																																																																																										
USER INPUT 2	5 ⊗	11 ⊗	12 ⊗	10 ⊗	DC OUT/IN ---																																																																																										

## C48TXX1X VERSIONS (18 TO 36 VDC/24 VAC POWERED)

C48TS - SINGLE PRESET RELAY AND SOLID-STATE OUTPUTS		C48TD - DUAL PRESET RELAY OUTPUTS		C48TD - DUAL PRESET SOLID-STATE OUTPUTS																																																																																											
<p>RS-485 OPTION B(-) A(+)</p> <table border="1"> <tr> <td>COMM.</td> <td>1 ⊗</td> <td>13 ⊗</td> <td>14 ⊗</td> <td>6 ⊗</td> <td>USER INPUT 1</td> </tr> <tr> <td>O1-SS</td> <td>2 ⊗</td> <td>⊗</td> <td>⊗</td> <td>7 ⊗</td> <td>RUN/STOP</td> </tr> <tr> <td>O1-RLY</td> <td>3 ⊗</td> <td></td> <td></td> <td>8 ⊗</td> <td>USER INPUT 3</td> </tr> <tr> <td>O1-RLY</td> <td>4 ⊗</td> <td>⊗</td> <td>⊗</td> <td>9 ⊗</td> <td>COMM.</td> </tr> <tr> <td>USER INPUT 2</td> <td>5 ⊗</td> <td>11 ⊗</td> <td>12 ⊗</td> <td>10 ⊗</td> <td>DC OUT/IN (V<sub>src</sub> IN)</td> </tr> </table> <p>DC+ DC- (AC) (AC)</p>		COMM.	1 ⊗	13 ⊗	14 ⊗	6 ⊗	USER INPUT 1	O1-SS	2 ⊗	⊗	⊗	7 ⊗	RUN/STOP	O1-RLY	3 ⊗			8 ⊗	USER INPUT 3	O1-RLY	4 ⊗	⊗	⊗	9 ⊗	COMM.	USER INPUT 2	5 ⊗	11 ⊗	12 ⊗	10 ⊗	DC OUT/IN (V <sub>src</sub> IN)	<p>RS-485 OPTION B(-) A(+)</p> <table border="1"> <tr> <td>O2-RLY</td> <td>1 ⊗</td> <td>13 ⊗</td> <td>14 ⊗</td> <td>6 ⊗</td> <td>USER INPUT 1</td> </tr> <tr> <td>O2-RLY</td> <td>2 ⊗</td> <td>⊗</td> <td>⊗</td> <td>7 ⊗</td> <td>RUN/STOP</td> </tr> <tr> <td>O1-RLY</td> <td>3 ⊗</td> <td></td> <td></td> <td>8 ⊗</td> <td>USER INPUT 3</td> </tr> <tr> <td>O1-RLY</td> <td>4 ⊗</td> <td>⊗</td> <td>⊗</td> <td>9 ⊗</td> <td>COMM.</td> </tr> <tr> <td>USER INPUT 2</td> <td>5 ⊗</td> <td>11 ⊗</td> <td>12 ⊗</td> <td>10 ⊗</td> <td>DC OUT/IN (V<sub>src</sub> IN)</td> </tr> </table> <p>DC+ DC- (AC) (AC)</p>		O2-RLY	1 ⊗	13 ⊗	14 ⊗	6 ⊗	USER INPUT 1	O2-RLY	2 ⊗	⊗	⊗	7 ⊗	RUN/STOP	O1-RLY	3 ⊗			8 ⊗	USER INPUT 3	O1-RLY	4 ⊗	⊗	⊗	9 ⊗	COMM.	USER INPUT 2	5 ⊗	11 ⊗	12 ⊗	10 ⊗	DC OUT/IN (V <sub>src</sub> IN)	<p>RS-485 OPTION B(-) A(+)</p> <table border="1"> <tr> <td>COMM.</td> <td>1 ⊗</td> <td>13 ⊗</td> <td>14 ⊗</td> <td>6 ⊗</td> <td>USER INPUT 1</td> </tr> <tr> <td>O1-SS</td> <td>2 ⊗</td> <td>⊗</td> <td>⊗</td> <td>7 ⊗</td> <td>RUN/STOP</td> </tr> <tr> <td>O2-SS</td> <td>3 ⊗</td> <td></td> <td></td> <td>8 ⊗</td> <td>USER INPUT 3</td> </tr> <tr> <td>N/C</td> <td>4 ⊗</td> <td>⊗</td> <td>⊗</td> <td>9 ⊗</td> <td>COMM.</td> </tr> <tr> <td>USER INPUT 2</td> <td>5 ⊗</td> <td>11 ⊗</td> <td>12 ⊗</td> <td>10 ⊗</td> <td>DC OUT/IN (V<sub>src</sub> IN)</td> </tr> </table> <p>DC+ DC- (AC) (AC)</p>		COMM.	1 ⊗	13 ⊗	14 ⊗	6 ⊗	USER INPUT 1	O1-SS	2 ⊗	⊗	⊗	7 ⊗	RUN/STOP	O2-SS	3 ⊗			8 ⊗	USER INPUT 3	N/C	4 ⊗	⊗	⊗	9 ⊗	COMM.	USER INPUT 2	5 ⊗	11 ⊗	12 ⊗	10 ⊗	DC OUT/IN (V <sub>src</sub> IN)
COMM.	1 ⊗	13 ⊗	14 ⊗	6 ⊗	USER INPUT 1																																																																																										
O1-SS	2 ⊗	⊗	⊗	7 ⊗	RUN/STOP																																																																																										
O1-RLY	3 ⊗			8 ⊗	USER INPUT 3																																																																																										
O1-RLY	4 ⊗	⊗	⊗	9 ⊗	COMM.																																																																																										
USER INPUT 2	5 ⊗	11 ⊗	12 ⊗	10 ⊗	DC OUT/IN (V <sub>src</sub> IN)																																																																																										
O2-RLY	1 ⊗	13 ⊗	14 ⊗	6 ⊗	USER INPUT 1																																																																																										
O2-RLY	2 ⊗	⊗	⊗	7 ⊗	RUN/STOP																																																																																										
O1-RLY	3 ⊗			8 ⊗	USER INPUT 3																																																																																										
O1-RLY	4 ⊗	⊗	⊗	9 ⊗	COMM.																																																																																										
USER INPUT 2	5 ⊗	11 ⊗	12 ⊗	10 ⊗	DC OUT/IN (V <sub>src</sub> IN)																																																																																										
COMM.	1 ⊗	13 ⊗	14 ⊗	6 ⊗	USER INPUT 1																																																																																										
O1-SS	2 ⊗	⊗	⊗	7 ⊗	RUN/STOP																																																																																										
O2-SS	3 ⊗			8 ⊗	USER INPUT 3																																																																																										
N/C	4 ⊗	⊗	⊗	9 ⊗	COMM.																																																																																										
USER INPUT 2	5 ⊗	11 ⊗	12 ⊗	10 ⊗	DC OUT/IN (V <sub>src</sub> IN)																																																																																										



## APPENDIX “E” - ORDERING INFORMATION

MODEL NO.	DESCRIPTION	NPN O.C. * OUTPUT(S)	RELAY OUTPUT(S)	RS485	PART NUMBER FOR AVAILABLE SUPPLY VOLTAGES		REPLACEMENT RELAY OUTPUT BOARDS
					18-36 VDC/24VAC	85 TO 250 VAC	
C48TS	1 Preset Timer, Reflective LCD	Yes	Yes	No	C48TS013	C48TS003	RBC48001
	1 Preset Timer, Backlit LCD	Yes	Yes	No	C48TS113	C48TS103	RBC48001
C48TD	2 Preset Timer, Reflective LCD	No	Yes	No	C48TD012	C48TD002	RBC48003
	2 Preset Timer, Reflective LCD	No	Yes	Yes	C48TD017	C48TD007	RBC48003
	2 Preset Timer, Reflective LCD	Yes	No	Yes	N/A	C48TD005	N/A
	2 Preset Timer, Backlit LCD	No	Yes	No	C48TD112	C48TD102	RBC48003
	2 Preset Timer, Backlit LCD	No	Yes	Yes	C48TD117	C48TD107	RBC48003
	2 Preset Timer, Backlit LCD	Yes	No	Yes	N/A	C48TD105	N/A

\* PNP O.C. Output(s) versions available. Contact the Factory.



## LIMITED WARRANTY

(a) Red Lion Controls Inc. (the “Company”) warrants that all Products shall be free from defects in material and workmanship under normal use for the period of time provided in “Statement of Warranty Periods” (available at [www.redlion.net](http://www.redlion.net)) current at the time of shipment of the Products (the “Warranty Period”). **EXCEPT FOR THE ABOVE-STATED WARRANTY, COMPANY MAKES NO WARRANTY WHATSOEVER WITH RESPECT TO THE PRODUCTS, INCLUDING ANY (A) WARRANTY OF MERCHANTABILITY; (B) WARRANTY OF FITNESS FOR A PARTICULAR PURPOSE; OR (C) WARRANTY AGAINST INFRINGEMENT OF INTELLECTUAL PROPERTY RIGHTS OF A THIRD PARTY; WHETHER EXPRESS OR IMPLIED BY LAW, COURSE OF DEALING, COURSE OF PERFORMANCE, USAGE OF TRADE OR OTHERWISE.** Customer shall be responsible for determining that a Product is suitable for Customer’s use and that such use complies with any applicable local, state or federal law.

(b) The Company shall not be liable for a breach of the warranty set forth in paragraph (a) if (i) the defect is a result of Customer’s failure to store, install, commission or maintain the Product according to specifications; (ii) Customer alters or repairs such Product without the prior written consent of Company.

(c) Subject to paragraph (b), with respect to any such Product during the Warranty Period, Company shall, in its sole discretion, either (i) repair or replace the Product; or (ii) credit or refund the price of Product provided that, if Company so requests, Customer shall, at Company’s expense, return such Product to Company.

**(d) THE REMEDIES SET FORTH IN PARAGRAPH (c) SHALL BE THE CUSTOMER’S SOLE AND EXCLUSIVE REMEDY AND COMPANY’S ENTIRE LIABILITY FOR ANY BREACH OF THE LIMITED WARRANTY SET FORTH IN PARAGRAPH (a).**

C48T/IM - D 06/17  
DRAWING NO. LP0356